

Acer LCD Monitor

User Guide

Copyright © 2021. Acer Incorporated.
All Rights Reserved.

Acer LCD Monitor User Guide
Original Issue: 03/2021

Changes may be made periodically to the information in this publication without obligation to notify any person of such revisions or changes. Such changes will be incorporated in new editions of this manual or supplementary documents and publications. This company makes no representations or warranties, either expressed or implied, with respect to the contents hereof and specifically disclaims the implied warranties of merchantability or fitness for a particular purpose.

Record the model number, serial number, purchase date and place of purchase information in the space provided below. The serial number and model number are recorded on the label affixed to your computer. All correspondence concerning your unit should include the serial number, model number and purchase information.

No part of this publication may be reproduced, stored in a retrieval system, or transmitted, in any form or by any means, electronically, mechanically, by photocopy, recording or otherwise, without the prior written permission of Acer Incorporated.

Acer LCD Monitor User Guide

Model number: _____

Serial number: _____

Date of purchase: _____

Place of purchase: _____

Acer and the Acer logo are registered trademarks of Acer Incorporated. Other companies' product names or trademarks are used herein for identification purposes only and belong to their respective companies.

Information for your safety and comfort

Safety instructions

Read these instructions carefully. Keep this document for future reference. Follow all warnings and instructions marked on the product.

Special notes on LCD monitors

The following are normal with the LCD monitor and do not indicate a problem.

- Due to the nature of the fluorescent light, the screen may flicker during initial use. Turn off the power switch and then turn it on again to make sure the flicker disappears.
- You may find slightly uneven brightness on the screen depending on the desktop pattern you use.
- The LCD screen has 99.99% or more effective pixels. It may include blemishes of 0.01% or less such as a missing pixel or pixel lit all the time.
- Due to the nature of the LCD screen, an afterimage of the previous screen may remain after switching the image, when the same image is displayed for hours. In this case, the screen is recovered slowly by changing the image or turning off the power switch for a few hours.

Cleaning your monitor

Please carefully follow these guidelines when cleaning the monitor:

- Always unplug the monitor before cleaning.
- Use a soft cloth to wipe the screen and cabinet front and sides.

Accessibility

Be sure that the power outlet you plug the power cord into is easily accessible and located as close to the equipment operator as possible. When you need to disconnect power from the equipment, be sure to unplug the power cord from the electrical outlet.

Safe listening

To protect your hearing, follow these instructions.

- Gradually increase the volume until you can hear it clearly and comfortably and without distortion.
- After setting the volume level, do not increase it after your ears have adjusted.
- Limit the amount of time listening to music at high volume.
- Avoid turning up the volume to block out noisy surroundings.
- Turn the volume down if you can't hear people speaking near you.

Warnings

- Do not use this product near water.
- Do not place this product on an unstable cart, stand or table. If the product falls, it could be seriously damaged.
- Slots and openings are provided for ventilation to ensure reliable operation of the product and to protect it from overheating. These openings must not be blocked or covered. The openings should never be blocked by placing the product on a bed, sofa, rug or other similar surface. This product should never be placed near or over a radiator or heat register, or in a built-in installation unless proper ventilation is provided.
- Never push objects of any kind into this product through cabinet slots as they may touch dangerous voltage points or short-out parts that could result in a fire or electric shock. Never spill liquid of any kind onto or into the product.
- To avoid damage of internal components and to prevent battery leakage, do not place the product on a vibrating surface.
- Never use it under sporting, exercising, or any vibrating environment which will probably cause unexpected short current or damage internal devices.
- The adapter is only used for this monitor, do not be used for other purposes.
- Your device uses one of the following power supplies:
Manufacture: DELTA: ADP-120RH BBM (19V / 6.32A)

Using electrical power

- This product should be operated from the type of power indicated on the marking label. If you are not sure of the type of power available, consult your dealer or local power company.
- Do not allow anything to rest on the power cord. Do not locate this product where people will walk on the cord.

- If an extension cord is used with this product, make sure that the total ampere rating of the equipment plugged into the extension cord does not exceed the extension cord ampere rating. Also, make sure that the total rating of all products plugged into the wall outlet does not exceed the fuse rating.
- Do not overload a power outlet, strip or receptacle by plugging in too many devices. The overall system load must not exceed 80% of the branch circuit rating. If power strips are used, the load should not exceed 80% of the power strip's input rating.
- This product's power cord is equipped with a three-wire grounded plug. The plug only fits in a grounded power outlet. Make sure the power outlet is properly grounded before inserting the power cord plug. Do not insert the plug into a non-grounded power outlet. Contact your electrician for details.



.....

Warning! The grounding pin is a safety feature. Using a power outlet that is not properly grounded may result in electric shock and/or injury.



.....

Note: The grounding pin also provides good protection from unexpected noise produced by other nearby electrical devices that may interfere with the performance of this product.

- Use the product only with the supplied power supply cord set. If you need to replace the power cord set, make sure that the new power cord meets the following requirements: detachable type, UL listed/CSA certified, type SPT-2, rated 7 A 125 V minimum, VDE approved or its equivalent, 4.6 meters (15 feet) maximum length.

Product servicing

Do not attempt to service this product yourself, as opening or removing covers may expose you to dangerous voltage points or other risks. Refer all servicing to qualified service personnel.

Unplug this product from the wall outlet and refer servicing to qualified service personnel when:

- the power cord or plug is damaged, cut or frayed
- liquid was spilled into the product
- the product was exposed to rain or water
- the product has been dropped or the case has been damaged
- the product exhibits a distinct change in performance, indicating a need for service
- the product does not operate normally after following the operating instructions



Note: Adjust only those controls that are covered by the operating instructions, since improper adjustment of other controls may result in damage and will often require extensive work by a qualified technician to restore the product to normal condition.

Potentially explosive environments

Switch off your device in any area with a potentially explosive atmosphere and obey all signs and instructions. Potentially explosive atmospheres include areas where you would normally be advised to turn off your vehicle engine. Sparks in such areas could cause an explosion or fire resulting in bodily injury or even death. Switch off the device near depots, storage and distribution areas; chemical plants; or where blasting operations are in progress. Areas with a potentially explosive atmosphere are often, but not always, marked. They include below deck on boats, chemical transfer or storage facilities, vehicles using liquefied petroleum gas (such as propane or butane), and areas where the air contains chemicals or particles such as grain, dust or metal powders.

Additional safety information

Your device and its enhancements may contain small parts. Keep them out of the reach of small children.

IT Equipment Recycling Information

Acer is strongly committed to environmental protection and views recycling, in the form of salvaging and disposal of used equipment, as one of the company's top priorities in minimizing the burden placed on the environment.

We at Acer are very conscious of the environmental effects of our business and strive to identify and provide the best working procedures to reduce the environmental impact of our products.

For more information and help when recycling, please go to this website:

<https://www.acer-group.com/sustainability/en/our-products-environment.html>

Visit www.acer-group.com for further information on the features and benefits of our other products.

Disposal instructions



Do not throw this electronic device into the trash when discarding. To minimize pollution and ensure utmost protection of the global environment, please recycle. For more information on the Waste from Electrical and Electronics Equipment (WEEE) regulations, visit <https://www.acer-group.com/sustainability/en/our-products-environment.html>

LCD pixel statement

The LCD unit is produced with high-precision manufacturing techniques. Nevertheless, some pixels may occasionally misfire or appear as black or red dots. This has no effect on the recorded image and does not constitute a malfunction.

This product has been shipped enabled for power management:

- Activate display's Sleep mode within 5 minutes of user inactivity.
- Wake the monitor when it is in Active Off mode, move the mouse or press any keyboard key.

Tips and information for comfortable use

Computer users may complain of eyestrain and headaches after prolonged use. Users are also at risk of physical injury after long hours of working in front of a computer. Long work periods, bad posture, poor work habits, stress, inadequate working conditions, personal health and other factors greatly increase the risk of physical injury.

Incorrect computer usage may lead to carpal tunnel syndrome, tendonitis, tenosynovitis or other musculoskeletal disorders. The following symptoms may appear in the hands, wrists, arms, shoulders, neck or back:

- numbness, or a burning or tingling sensation
- aching, soreness or tenderness
- pain, swelling or throbbing
- stiffness or tightness
- coldness or weakness

If you have these symptoms, or any other recurring or persistent discomfort and/or pain related to computer use, consult a physician immediately and inform your company's health and safety department.

The following section provides tips for more comfortable computer use.

Finding your comfort zone

Find your comfort zone by adjusting the viewing angle of the monitor, using a footrest, or raising your sitting height to achieve maximum comfort. Observe the following tips:

- refrain from staying too long in one fixed posture
- avoid slouching forward and/or leaning backward
- stand up and walk around regularly to remove the strain on your leg muscles

Taking care of your vision

Long viewing hours, wearing incorrect glasses or contact lenses, glare, excessive room lighting, poorly focused screens, very small typefaces and low-contrast displays could stress your eyes. The following sections provide suggestions on how to reduce eyestrain.

Eyes

- It is recommended to rest your eyes for 10 minutes every 40 minutes.
- Give your eyes regular breaks by looking away from the monitor and focusing on a distant point.
- Blink frequently to keep your eyes from drying out.

Display

- Keep your display clean.
- Keep your head at a higher level than the top edge of the display so your eyes point downward when looking at the middle of the display.
- Adjust the display brightness and/or contrast to a comfortable level for enhanced text readability and graphics clarity.
- Eliminate glare and reflections by:
 - placing your display in such a way that the side faces the window or any light source
 - minimizing room light by using drapes, shades or blinds
 - using a task light
 - changing the display's viewing angle
 - using a glare-reduction filter
 - using a display visor, such as a piece of cardboard extended from the display's top front edge
- Avoid adjusting your display to an awkward viewing angle.
- Avoid looking at bright light sources, such as open windows, for extended periods of time.

Developing good work habits

Develop the following work habits to make your computer use more relaxing and productive:

- Take short breaks regularly and often.
- Perform some stretching exercises.
- Breathe fresh air as often as possible.
- Exercise regularly and maintain a healthy body.



Acer Incorporated
8F, 88, Sec. 1, Xintai 5th Rd., Xizhi
New Taipei City 221, Taiwan

Declaration of Conformity

We,
Acer Incorporated
8F, 88, Sec. 1, Xintai 5th Rd., Xizhi, New Taipei City 221, Taiwan

And,
Acer Italy s.r.l.
Viale delle Industrie 1/A, 20020 Arese (MI), Italy
Tel: +39-02-939-921 ,Fax: +39-02 9399-2913
www.acer.it

| | |
|----------------------|--|
| Product: | LCD Monitor |
| Trade Name: | Acer |
| Model Number: | XB273U NX |
| SKU Number: | XB273U NX xxxxxx; |
| | ("x" = 0~9, a~z, A~Z, or blank) |

We, Acer Incorporated, hereby declare under our sole responsibility that the product described above is in conformity with the relevant Union harmonization legislations as below Directive and following harmonized standards and/or other relevant standards have been applied:

EMC Directive: 2014/30/EU

| | |
|---|---|
| <input checked="" type="checkbox"/> EN 55032:2012/AC:2013 Class B | <input checked="" type="checkbox"/> EN 55035:2017 |
| <input checked="" type="checkbox"/> EN 55032:2015+AC 2016 Class B | <input checked="" type="checkbox"/> EN 61000-3-3:2013 |
| <input checked="" type="checkbox"/> EN 61000-3-2:2014 Class D | |

LVD Directive: 2014/35/EU

EN 62368-1: 2014+A11:2017

RoHS Directive: 2011/65/EU

EN 50581:2012

ErP Directive: 2009/125/EC

Regulation (EU) 2019/2021;EN50564:2011;EN62087

Year to begin affixing CE marking: 2021.

Ru Jan / Sr. Manager
Acer Incorporated (Taipei, Taiwan)

Mar.30,2021
Date

acer

Acer America Corporation
333 West San Carlos St., San Jose
Suite 1500
CA 95110, U. S. A.
Tel : 254-298-4000
Fax : 254-298-4147
www.acer.com



Federal Communications Commission Supplier's Declaration of Conformity

This device complies with Part 15 of the FCC Rules. Operation is subject to the following two conditions: (1) this device may not cause harmful interference, and (2) this device must accept any interference received, including interference that may cause undesired operation.

The following local Manufacturer /Importer is responsible for this declaration:

| | |
|--------------------------------------|---|
| Product: | LCD Monitor |
| Model Number: | XB273U NX |
| SKU Number: | XB273U NX xxxxxx ("x" = 0~9, a ~ z, or A ~ Z) |
| Name of Responsible Party: | Acer America Corporation |
| Address of Responsible Party: | 333 West San Carlos St. Suite 1500 San Jose, CA 95110 U. S. A. |
| Contact Person: | Acer Representative |
| Phone No.: | 254-298-4000 |
| Fax No.: | 254-298-4147 |

Contents

| | |
|---|-----------|
| Information for your safety and comfort | 3 |
| Safety instructions | 3 |
| Special notes on LCD monitors | 3 |
| Cleaning your monitor | 3 |
| Accessibility | 4 |
| Safe listening | 4 |
| Warnings | 4 |
| Using electrical power | 4 |
| Product servicing | 5 |
| Potentially explosive environments | 6 |
| Additional safety information | 6 |
| IT Equipment Recycling Information | 6 |
| Disposal instructions | 6 |
| LCD pixel statement | 7 |
| Tips and information for comfortable use | 7 |
| Finding your comfort zone | 7 |
| Taking care of your vision | 8 |
| Developing good work habits | 8 |
| Federal Communications Commission | 10 |
| Supplier's Declaration of Conformity | 10 |
| Unpacking | 12 |
| Attaching the Base | 13 |
| Connecting the adapter and AC Power cord | 15 |
| Power saving | 15 |
| Display Data Channel (DDC) | 16 |
| 20-pin color display signal cable | 16 |
| 19-pin color display signal cable | 17 |
| Standard timing table | 18 |
| Installation | 19 |
| Troubleshooting | 30 |
| HDMI/DP Mode (Optional) | 30 |

Unpacking

Please check that the following items are present when you unpack the box, and save the packing materials in case you need to ship or transport the monitor in the future.

LCD monitor

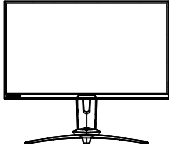

Quick start guide



AC Power cord



DP Cable
(Optional)

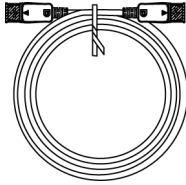

HDMI cable
(Optional)

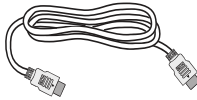

USB cable
(Optional)

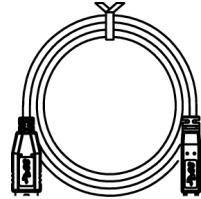

- **Attaching the Base**

Note: Remove the monitor and monitor base from its packaging. Carefully place the monitor face-down on a stable surface -- use a cloth to avoid scratching the screen.

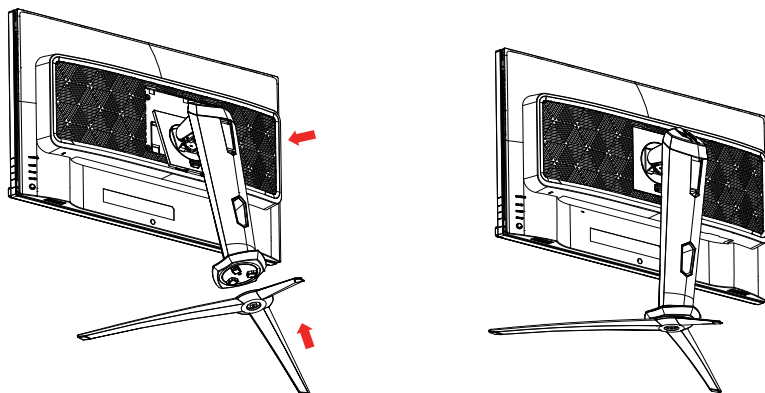

- **Height Adjustment**

After pressing the top of the monitor then you can adjust the height of the monitor.

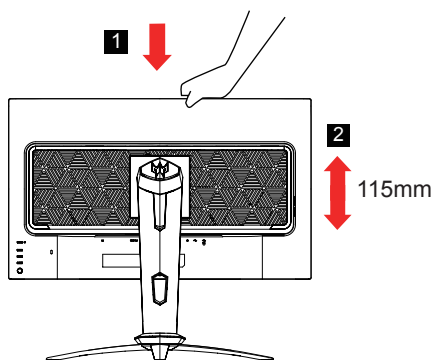

- **Tilt**

Please see the illustration below for an example of the tilt range. Only at the highest point can 25 degrees of recline be offered for the angle of elevation.

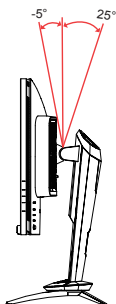

- **Swivel**

With the built-in pedestal, you can swivel the monitor for the most comfortable viewing angle.

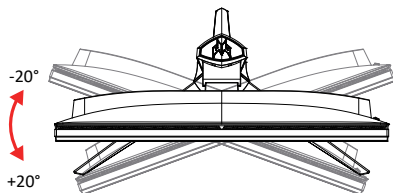

- **Monitor Pivot**

Before rotating the display, lift it to the top position and then push it back to the utmost degree. Rotate clockwise or counter-clockwise until the monitor stops at $\pm 90^\circ$.

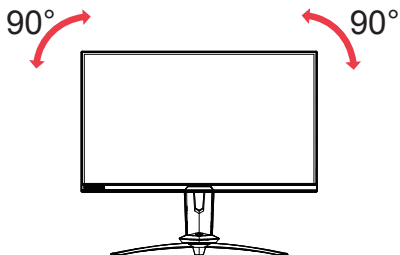

Connecting the adapter and AC Power cord

- Check first to make sure that the power cord you use is the correct type required for your area.
- The monitor has a universal power supply that allows operation in either 100/120 V AC or 220/240 V AC voltage area. No user-adjustment is required.
- Plug one end of the AC power cord to the Adapter, and plug the other end into an AC outlet.
- For units using 120 V AC:
Use a UL-listed cord set, type SVT wire and plug rated 10 A/125 V.
- For units using 220/240 V AC:
Use a cord set consisting of H05VV-F cord and plug rated 10 A/250 V. The cord set should have the appropriate safety approvals for the country in which the equipment will be installed.

Power saving

The monitor will be driven into "Power Saving" mode by the control signal from the display controller, as indicated by the amber-color power LED.

| State | LED Light |
|-------------------|-----------|
| ON | Blue |
| Power Saving Mode | Amber |

The power saving states will be kept until a control signal has been detected or the keyboard or mouse is activated. The recovery time from Active OFF state back to ON state is around 3 seconds.

Display Data Channel (DDC)

To make installation easier, so long as your system supports the DDC protocol, the monitor is able to plug-and-play. The DDC is a communication protocol through which the monitor automatically informs the host system about its capabilities; for example, supported resolutions and corresponding timing. The monitor supports the DDC2B standard.

20-pin color display signal cable

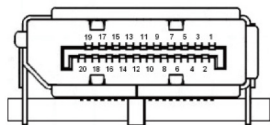

| PIN No. | Description | PIN No. | Description |
|---------|-------------|---------|-------------|
| 1 | ML_Lane 0+ | 2 | GND |
| 3 | ML_Lane 0- | 4 | ML_Lane 1+ |
| 5 | GND | 6 | ML_Lane 1- |
| 7 | ML_Lane 2+ | 8 | GND |
| 9 | ML_Lane 2- | 10 | ML_Lane 3+ |
| 11 | GND | 12 | ML_Lane 3- |
| 13 | KONFIG1 | 14 | CONFIG2 |
| 15 | AUX CH+ | 16 | GND |
| 17 | AUX CH- | 18 | Hot Plug |
| 19 | Return | 20 | DP_PWR |

19-pin color display signal cable

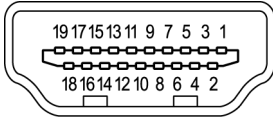

| PIN No. | Description | PIN No. | Description |
|---------|-------------------|---------|---------------------------|
| 1 | TMDS Data2+ | 2 | TMDS Data2 Shield |
| 3 | TMDS Data2- | 4 | TMDS Data1+ |
| 5 | TMDS Data1 Shield | 6 | TMDS Data1- |
| 7 | TMDS Data0+ | 8 | TMDS Data0 Shield |
| 9 | TMDS Data0- | 10 | TMDS Clock+ |
| 11 | TMDS Clock Shield | 12 | TMDS Clock- |
| 13 | CEC | 14 | Reserved (N.C. on device) |
| 15 | SCL | 16 | SDA |
| 17 | DDC/CEC Ground | 18 | +5V Power |
| 19 | Hot Plug Detect | | |

Standard timing table

| VESA MODE | | | |
|-----------|------------|-----------|---------|
| MODE | Resolution | | |
| 1 | VGA | 640x480 | 60Hz |
| 2 | MAC | 640x480 | 66.66Hz |
| 3 | VESA | 720x400 | 70Hz |
| 4 | SVGA | 800x600 | 56Hz |
| 5 | SVGA | 800x600 | 60Hz |
| 6 | XGA | 1024x768 | 60Hz |
| 7 | XGA | 1024x768 | 70Hz |
| 8 | SXGA | 1280x1024 | 60Hz |
| 9 | VESA | 1280x720 | 60Hz |
| 10 | WXGA | 1280x800 | 60Hz |
| 11 | UXGA | 1920x1080 | 60Hz |
| 12 | UXGA | 1920x1080 | 120Hz |
| 13 | QHD | 2560x1440 | 120Hz |
| 14 | QHD | 2560x1440 | 144Hz |
| 15 | QHD | 2560x1440 | 240Hz* |
| 16 | QHD | 2560x1440 | 275Hz* |

* only DP input support.

Installation

1. Turn off your computer and unplug your computer's power cord.
2. Connect the signal cable to the HDMI (optional) and /or DP (optional) input socket of the monitor, and the HDMI (optional) and /or DP (optional) output socket of the graphics card on the computer.
3. Connect the USB Cable(Optional)
Connect the USB cable to port for fast charge.
Connect the USB cable to port.
4. Insert the monitor power cable into the power port at the back of the monitor.
5. Connect the power adapter and power cord to the monitor, then to a properly grounded AC outlet.

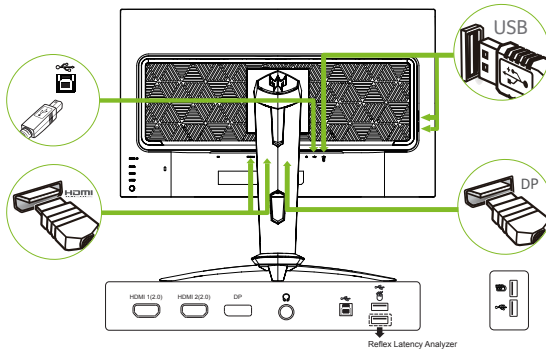

Note: Audio output is only for audio output model. Please check user manual for more instruction.

User Controls



1



2



3







4



5

External controls

| | | |
|---|---|--|
| 1 | Power button | Turns the monitor on/off. Blue indicates power on. Amber indicates standby/ power saving mode. |
| 2 | Function key  | <ol style="list-style-type: none"> Press to view Main page. Press again to enter hotkey1 function. When the Function Menu is active, press this key to view the basic information for your monitor and current input or reset the custom color settings to the factory defaults. |
| 3 | Function key  | <ol style="list-style-type: none"> Press to view Main page. Press again to enter hotkey2 function. When the Function Menu is active, press this button to select select scenario mode or game mode . |
| 4 | Function key  | <ol style="list-style-type: none"> Press to view Main page. Press again to enter Input select function. When the Function Menu is active, this button will quit the OSD. |
| 5 | Function key  | <ol style="list-style-type: none"> Press to view Main page. Press again to enter next function in the Function Menu. The single toggle button on the backside of the Display bezel operates like a joystick. To move the cursor, simply toggle the button in four directions. Press the button to select desired option. Red indicates operable. Dark gray indicates inoperable. |

G-SYNC :

G-SYNC requires an NVIDIA GeForce GTX 1070 BOOST GPU or higher. For more information, visit the nVidia® website: <http://www.nvidia.com/page/home.html>

Using the Shortcut Menu



Note: The following content is for general reference only. Actual product specifications may vary.

The OSD (On Screen Display) can be used to adjust the settings of your LCD monitor. Press the MENU key to open the OSD. You can use the OSD to adjust the picture quality, OSD position and general settings. For advanced settings, please refer to following page:

Main page

| | |
|--|---|
| | <ol style="list-style-type: none"> Hot Key1 Modes, Brightness, Contrast, Blue Light, Volume, Over Drive, Relative Gamma Hot Key2 Modes, Brightness, Contrast, Blue Light, Volume, Over Drive, Relative Gamma Hot Key3 Input Switch Hot Key |
|--|---|

Hot key1 (default: Standard mode)

To choose game mode(G1, G2, G3) which user-defined profile to use or scenario mode (User, Standard, ECO, Graphics, Movie)

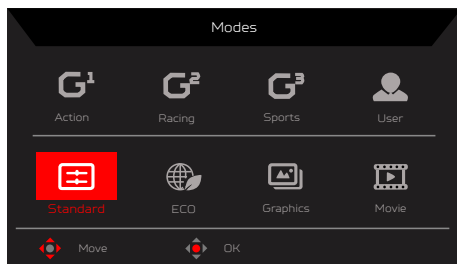

Hot key2 (default: Peak white (nits))

Open the Peak white (nits) control and select your preferred Peak white (nits) setting . When you are done, press the joystick to quit current page and store.







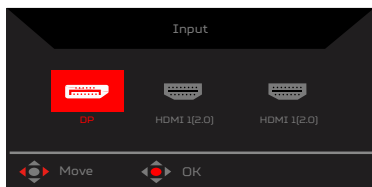



Selecting the input

Open the Input control and select HDMI1(2.0), HDMI2(2.0), DP or Auto Source. When you are done, press the joystick to exit current page and store.



Main menu

1. Press the MENU key to open the OSD.
2. Toggle the joystick  to the up  or down  to select Picture from the OSD. The toggle to the right to navigate to the element you wish to adjust and press the joystick to enter it.
3. Toggle the joystick  to the left  or right  to adjust the sliding scales.
 Information Hot Key  : Show Monitor Information and Reset control function.
 Modes Hot Key  : To change Modes Hot Key menu.
 Exit Hot Key  : To exit current page and store.

Picture

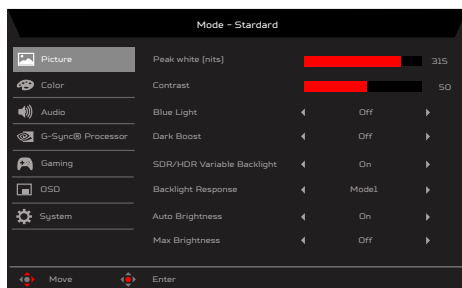

1. Press the MENU key to open the OSD.
2. Toggle the joystick to the up or down to select Picture from the OSD. Then toggle to the right to navigate to the element you wish to adjust and press the joystick to enter it.
3. Toggle to the left or right to adjust the sliding scales.
4. The Picture menu can be used to adjust the Peak white (nits), Contrast, Blue Light, Dark Boost, SDR/HDR Variable Backlight, Backlight Response, Auto Brightness.

5. Peak white (nits): Adjust the brightness from 0 to 450.



Note: Adjusts the balance between light and dark shades.

6. Contrast: Adjust the contrast from 0 to 100.



Note: Sets the degree of difference between light and dark areas.

7. Dark Boost: Dark Boost adjusts the lower half of the nominal EOTF gamma curve so

that dark values appear brighter on screen.

- Blue Light: Filters out blue light to protect your eyes by adjusting how much blue light is shown --- Off, 90%, 70%, 60%, or 50%.



Note: Higher values allow more blue light through. For the best protection select a lower value.

When "Blue Light" is on, Brightness & Contrast will show each level of "Blue Light" value.

50 % is compliance with TUV Low Blue Light Certification.

- SDR/HDR Variable Backlight: Adjust Variable mode backlight ON/OFF.
- Backlight Response: This sets the basic response time to the variable backlight.
- Auto Brightness: NVIDIA function.
Display maximum luminance control (automatic brightness control)
Off: Use fixed value.
On: Use automatic value guided by light sensor.
Default is: On
- Max Brightness
Default: OFF
Off: Lower brightness
On: Restore original brightness.
When "Max Brightness" be changed, "Modes" will be reset to "Standard".

Color

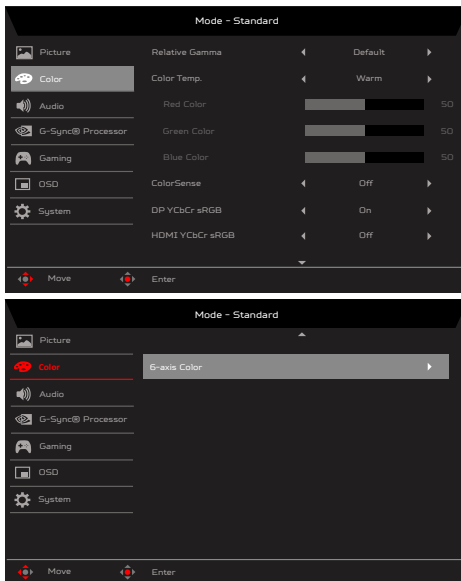

- Press the MENU key to open the OSD.
- Toggle the joystick to the up or down to select Color from the OSD. Then toggle the right to navigate to the element you wish to adjust and press the joystick to enter it.

3. Toggle to the left or right to adjust the sliding scales.
4. Relative Gamma: NVIDIA function.
Gamma can only be applied to SDR EOTF curves (sRGB, BT.1886). HDR gamma is absolute and can't be changed.
sRGB by default follows the sRGB gamma specification, which is on average close to 2.2. BT.1886 by default follows a natural 2.4 gamma.
5. Color temperature: Default is warm. You can choose Cool, Normal, Warm, Bluelight or User.
6. ColorSense: According to the CCT data read by ColorSense, the Monitor color temperature will be changed between 5000, 5500, 6500 and 7000. (Changed delay time < 4s).
7. DP YCbCr sRGB: NVIDIA function
Gamma curve selection for YCbCr formats on DP input in SDR mode;
When enabled (default), the DP input will use sRGB gamma to display YCbCr inputs.
When disabled, the DP input will use BT1886 gamma to display YCbCr inputs.
8. HDMI YCbCr sRGB: NVIDIA function
Gamma curve selection for YCbCr formats on HDMI input in SDR mode;
When enabled, the HDMI input will use sRGB gamma to display YCbCr inputs.
When disabled (default), the HDMI input will use BT1886 gamma to display YCbCr inputs.
9. 6-axis Color: Adjust the red, green, blue, yellow, magenta and cyan color.

Audio



1. Press the MENU key to open the OSD.
2. Toggle the joystick to the up or down to select Audio from the OSD. Then toggle to the right to navigate to the element you wish to adjust and press the joystick to enter it.
3. Toggle to the left or right to adjust the sliding scales.
4. Volume: Adjust the volume.

G-Sync® Processor

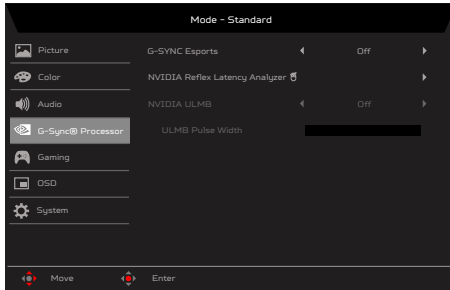

1. Press the MENU key to open the OSD.
2. Toggle the joystick to the up or down to select G-Sync® Processor from the OSD. Then toggle to the right to navigate to the element you wish to adjust and press the joystick to enter it.
3. Toggle to the left or right to control functions.
4. G-SYNC Esports: To choose G-SYNC Esports on/off.



Note:

Esports ON:

- Brightness = maximum
- Dark Boost = Level3
- SDR/HDR Variable Backlight = ON (in HDR), OFF (in SDR)
- Auto Brightness = OFF
- Relative Gamma = -0.2

Esports OFF:

- Brightness = Restore previous setting
- Dark Boost = Restore previous setting
- SDR/HDR Variable Backlight = Restore previous setting
- Auto Brightness = Restore previous setting
- Relative Gamma = Restore previous setting

5. NVIDIA Reflex Latency Analyzer:
Reflex Latency Analyzer works by detecting the clicks coming from your mouse and measuring the time it takes for a resulting display pixel change (i.e. gun fire) to happen on the screen, providing you with a full System Latency measurement.
6. NVIDIA ULMB: It can be enabled on 120/144Hz.

Gaming

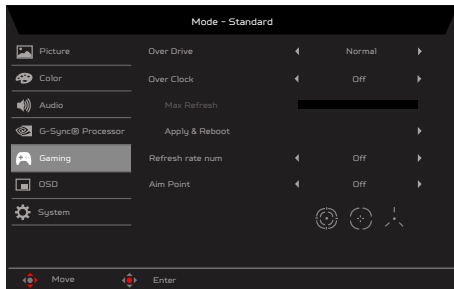

1. Press the MENU key to open the OSD.
2. Toggle the joystick to the up or down to select Gaming from the OSD. Then toggle to the right to navigate to the element you wish to adjust and press the joystick to enter it.
3. Toggle to the left or right to control functions.
4. Over Drive: Select Off, Normal or Extreme.



Note: The default is "normal", but also optional for the "Extreme" the fastest response time.

5. Over Clock: The default is "Off"
When Over Clock = "Off", It support max resolution to 2560x1440 @240Hz.
When Over Clock = "On", you can use "Max Refresh" to adjust.
After changing the "Max Refresh", press "Apply and Reboot" to apply this settings.
6. Refresh rate num: Display the panel's current refresh rate on the screen.
7. Aim point: Show an Aim point on the screen for shooting games.

OSD

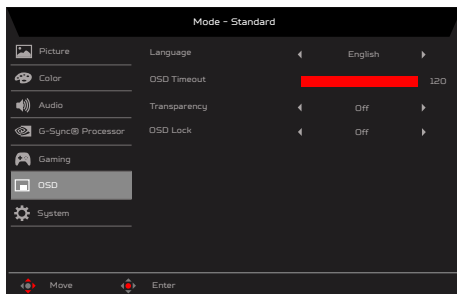

1. Press the MENU key to open the OSD.
2. Toggle the joystick to the up or down to select OSD from the OSD. Then toggle to the right to navigate to the element you wish to adjust and press the joystick to enter it.
3. Toggle to the left or right to adjust the sliding scales.

4. Language: Set the OSD menu language.
5. OSD timeout: Adjust the delay before turning off the OSD menu.
6. Transparency: Select the transparency when using gaming mode. The transparency can be 0% (OFF), 20%, 40%, 60%, or 80%.
7. OSD Lock: To choose OSD lock on/off.

**Note:**

OSD Locked:

- Set the OSD Lock to "On" by the OSD option and press "Enter" to execute the All Key lock function.
- The "OSD Locked" message will be displayed in the middle of the screen.
- Press any Key screen to prompt "OSD Locked" message.

OSD Unlocked:

- In normal display condition to press the "Navi Key" in the middle of more than 3 seconds to trigger "OSD Unlock".
- The "OSD Unlock" message will be displayed in the middle of the screen.

System

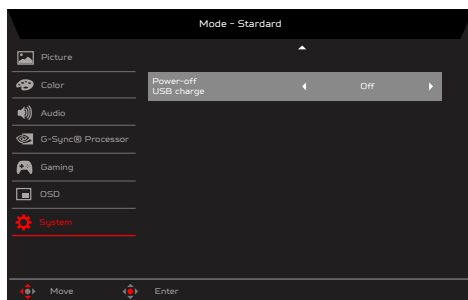
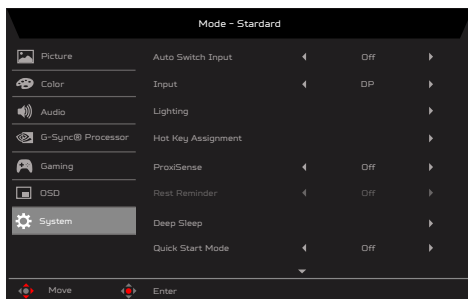

1. Press the MENU key to open the OSD.
2. Toggle the joystick to the up or down to select System from the OSD. Then toggle to the

right to navigate to the element you wish to adjust and press the joystick to enter it.

3. Toggle to the left or right to control functions.
4. Auto Switch Input: The default is "On", which can support auto search for signal source in order.
5. Input: Select the source from HDMI1(2.0), HDMI2(2.0), DP.
6. Lighting: Ambient light, choose to follow a favorite to many functions.
 - Lighting Switch: Lighting main switch, default is "Enable".
 - Lighting Style: 9 kinds of style choice. Static (Default), Shifting, Filling, Breathing, Motion, Zoom, Spectrum, Wave, Starlight flashing.
 - Lighting Color: 6 kinds of manually select the lighting color. Blue (Default), Red, Green, Yellow, Magenta, Cyan.
 - Lighting Brightness: Control lighting brightness value, when choose "Auto" that LED brightness will depend on lightsense.
 - Lighting Health: When user select to Warm/ Normal/ Cool, LED brightness & LED color R, G, B value are adjustment by setting value. When user select to disable, Lighting will be return to previous lighting style.
7. Hot Key Assignment: Select the function of shortcut key 1 (Modes, Volume, Brightness, Gamma, Contrast, Blue Light, Over Drive, VRB) and shortcut keys 2 (Modes, Volume, Brightness, Gamma, Contrast, Blue Light, Over Drive, VRB).
8. ProxiSense: ProxiSense works on principle of transmission and reception of harmless "infrared" signals in order to detect user-presence.



Note:

- If the user is away for more than 60 seconds, monitor brightness and contrast will be reduced to 50%.
- If the user is away for more than 180 seconds, monitor brightness and contrast will be set to minimum.
- The brightness and contrast can be restored by tuning on the OSD menu or user coming back.

9. Rest Reminder

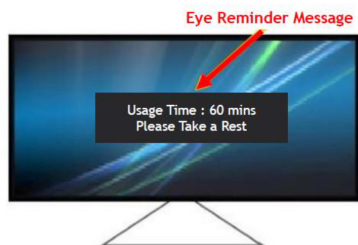

The pop-up menu display timeout: the same with main OSD. (Click any button can turn off it.) Timer will be restarted when user comeback again or this pop-up menu be closed.

10. Deep Sleep: Default is on.



Note:

- When Deep sleep is set to on and no signal, the monitor will go to sleep

mode after 10 minutes.

- When Deep sleep is set to off and no signal, the monitor will not go to sleep mode.
11. Quick start mode: Select Off or On. Turn on to speed up boot speed.
 12. Power-off USB charge: Turn On or Off. On: DC off/Saving mode can to electrify for USB port. Off: DC off/Saving mode can't to electrify for USB port.

Save Setting to...(User mode only)

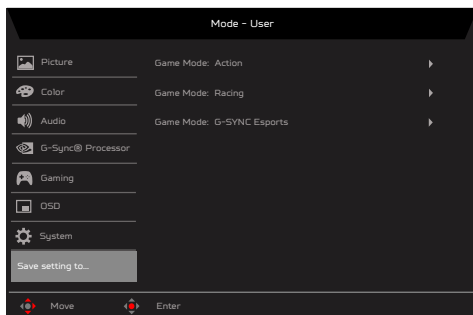

1. Press the MENU key to open the OSD.
2. Toggle the joystick to the up or down to select "Save Setting to..." from the OSD. Then toggle to the right to navigate to the element you wish to adjust and press the joystick to enter it.
3. Save Setting to Game mode: There are three user-defined profiles available. When you have decided what settings suit you, save them and system will be able to recall the settings in the future when you turn on gaming mode .

Troubleshooting

Before sending your LCD monitor for servicing, please check the troubleshooting list below to see if you can self-diagnose the problem.

HDMI/DP Mode (Optional)

| Problem | LED status | Remedy |
|--------------------|------------|--|
| No picture visible | Blue | Using the OSD menu, adjust brightness and contrast to maximum or reset to their default setting. |
| | Off | Check the power switch. Check if the AC power cord is properly connected to the monitor. |
| | Amber | Check if the video signal cable is properly connected at the back of monitor. Check if the computer system is switched on and in power saving/standby mode. |

Note: Acer monitor is purposed for video and visual display of information obtained from electronic devices.

Regulatory Compliance

