

acer

B3-A42



Iconia One 10

USER'S MANUAL

© 2018 All Rights Reserved

Acer Iconia One 10 User's Manual

Covers: B3-A42

Regulatory Model Number (RMN): A8201

This revision: January 2018

Sign up for an Acer ID and enjoy great benefits

There are three great reasons for you to get an Acer ID:

- Create your own connected world.
- Get the latest offers and product information.
- Register your device for quick, personalized customer support.

For more information, please visit the Acer website: account.acer.com



Important

This manual contains proprietary information that is protected by copyright laws. The information contained in this manual is subject to change without notice. Images provided herein are for reference only and may contain information or features that do not apply to your computer. Acer Group shall not be liable for technical or editorial errors or omissions contained in this manual.

Acer Iconia One 10

Model number: _____

Serial number: _____

Date of purchase: _____

Place of purchase: _____

Google, Android, Google Play, YouTube and other marks are trademarks of Google LLC.

TABLE OF CONTENTS

Getting started with your tablet	4	Going online	29
Features and functions	4	Managing Wi-Fi connections	29
Unpacking your tablet.....	4	Data saver (background data)	29
Getting to know your tablet.....	5	Browsing the internet	30
Using the SIM card slot	6	Google™ services	31
Turning on for the first time.....	7	Using the camera and video recorder	36
Charging your tablet	9	Camera/video icons and indicators.....	36
Assembling the power adapter.....	9	Taking a photo	37
Using your tablet	11	Recording a video	37
Using the touchscreen.....	11	Camera and video options.....	38
The Home screen	11	Advanced settings	40
The virtual keyboard	22	Wireless & Networks.....	40
Editing text.....	23	Device	42
Setting an alarm	24	Personal.....	44
Waking your tablet.....	25	System.....	45
Shutting down your tablet.....	25	Updating your tablet's operating system	45
Connecting devices to your tablet	26	Resetting your tablet.....	45
Connecting to AC power.....	26	FAQ and troubleshooting	46
Inserting a microSD card	26	Other sources of help	47
Transferring files between your tablet and a PC.....	26	Specifications	48
Connecting a Bluetooth device.....	27	Guidelines for safe battery usage	51
Accessories	28	Battery information.....	51
		Replacing the battery	52
		End user license agreement	53

GETTING STARTED WITH YOUR TABLET

Features and functions

Your new tablet offers leading, easy-to-access multimedia and entertainment features. You can:

- Connect to the Internet via Wi-Fi or 3G.
- Access your email while on the move.
- Keep in touch with your friends with social networking apps.
- Watch movies or listen to music.
- Play games or read a book.

Unpacking your tablet

Your new tablet comes packed in a protective box. Carefully unpack the box and remove the contents. If any of the following items are missing or damaged, contact your dealer immediately:

- Acer Iconia tablet
- Product setup and safety information
- USB cable
- AC adapter
- Warranty card



Note

Before using your tablet for the first time, you need to charge it for at least four hours. After that you can recharge the battery as needed.



Note

If the battery has been depleted for a while, please charge the tablet for at least 30 minutes using the adapter.

Getting to know your tablet

Views

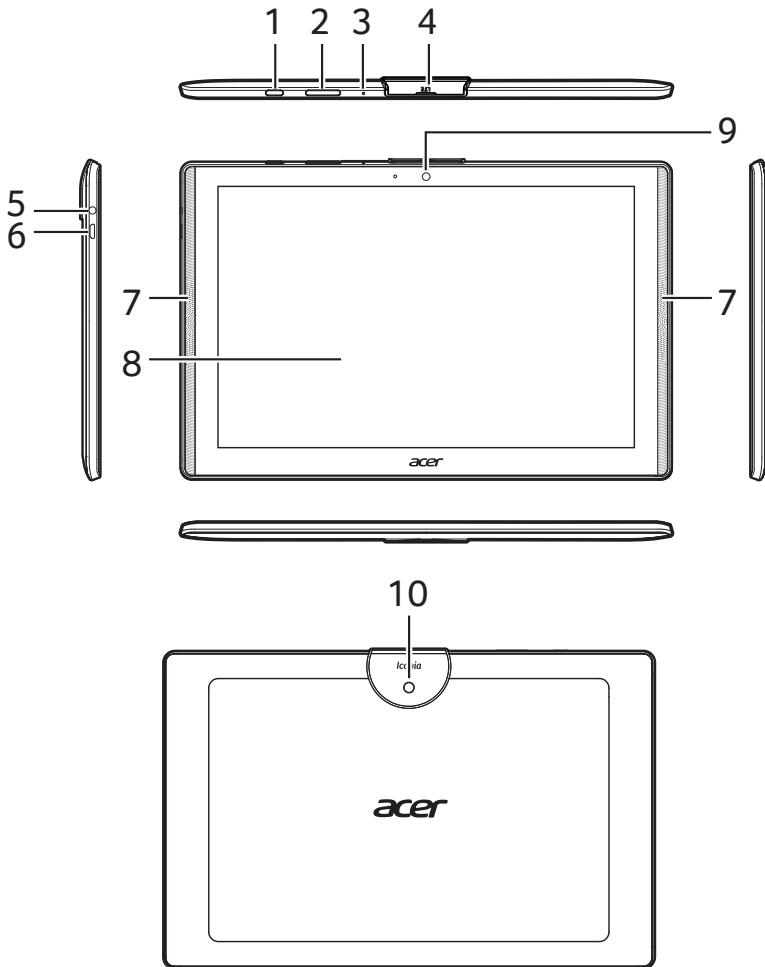

No.	Item	Description
1	Power button	Long press to turn the tablet on, press briefly to turn the screen on/off or enter sleep mode; press and hold to turn the tablet off.

No.	Item	Description
2	Volume control key	Increases and decreases the tablet volume.
3	Microphone	Receives audio for video chats and Internet calls.
	Cover for:	
4	microSD card slot	Insert a microSD card into the slot.
	SIM card slot	Insert a nano SIM card into the slot. see Inserting a SIM card on page 6
5	3.5 mm headphone jack	Connects to stereo headphones.
6	Micro USB port	Connects to a computer via a USB cable. Also serves as the charging port for the AC adapter. For more information, see Charging your tablet on page 9 .
7	Speakers	Emits audio.
8	Touchscreen	10.1" LED-backlit LCD.
9	Front-facing camera	A 2-megapixel camera for video chats and selfies.
10	Rear-facing camera	A 5-megapixel camera for taking high-resolution images.

Using the SIM card slot

Your tablet has a SIM slot for internet access. To take full advantage of your tablet's Internet capabilities, you should install a SIM card with data subscription *before* turning on your tablet.

Inserting a SIM card



Warning

Do not force the SIM card. If it does not fit, ensure you have the SIM card properly oriented as illustrated. Trying to force the SIM into the slot when it is incorrectly oriented may damage the SIM and/or your tablet.

To insert the SIM card, turn the tablet upside down. Insert the SIM card with the gold-colored connectors facing upwards and the cut-out towards the bottom of the tablet (see illustration).

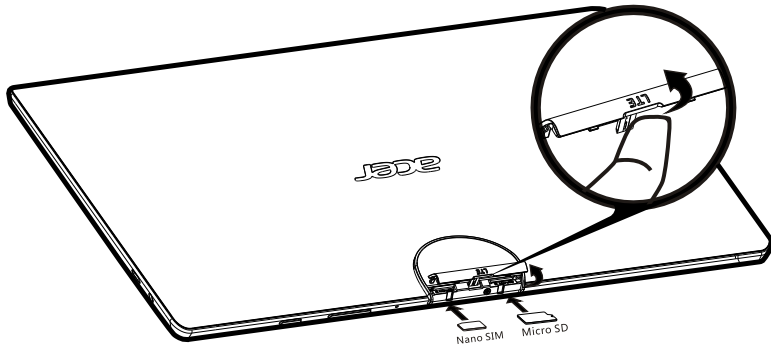

Turning on for the first time

To turn on your tablet, press and hold the power button until you see the Acer logo. Wait a moment for your tablet to boot up. You will then be asked some questions before you can use your tablet.

To start, tap to select your language then tap the arrow. Follow the rest of the instructions as they are displayed.

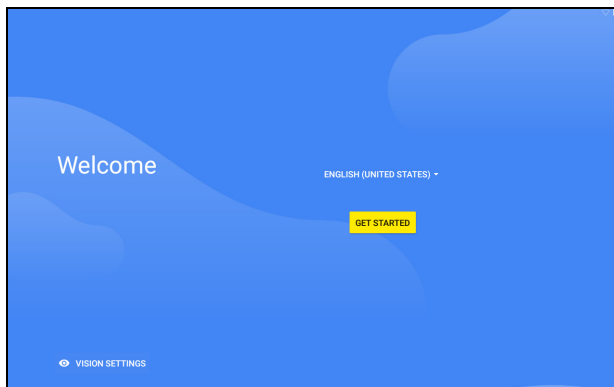

If the tablet's screen turns off, it has entered sleep mode. Briefly press the power button to wake it up. For more information [see Waking your tablet on page 25](#).

Sign in to or create a Google account

If you have Internet access, your tablet allows you to synchronize information with a Google account.

During the start-up process, you may create or sign in to an account, which will be used to synchronize your contact list, email, calendar and other information. If you do not yet have Internet access, or do not want to use this feature, then tap **Skip**.



Important

You must sign in to a Google Account to use Gmail, Hangouts, Google Calendar, and other Google apps; to download apps from Google Play; to back up your settings to Google servers; and to take advantage of other Google services on your tablet.

If you have multiple Google accounts, such as separate accounts for personal and business contacts, you can access and synchronize them from the *Accounts* settings section. [See Multiple Google accounts on page 44](#)



Note

If Google Play Store is updating apps in the background, opening new apps may consume memory and may affect the performance on your device.

CHARGING YOUR TABLET

Assembling the power adapter

Your tablet is bundled with one of two types of USB power adapters: a fixed-prong type or a removable-prong type. Both types are described in this manual.

Fixed-prong type

The prongs and power adapter body form a complete piece, no assembly required. Simply slide the large end of the USB cable into the power adapter body (it will fit in only one direction). You cannot remove or switch the prongs with this type of adapter.

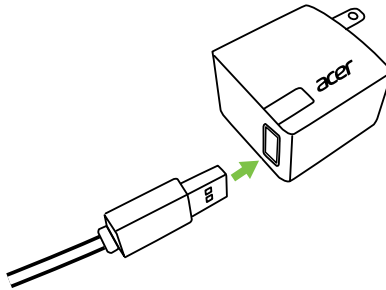

Removable-prong type

Align arrows on the power adapter head and body. Insert the head onto the power adapter body and turn the head towards "CLOSE" printed on the head until it clicks into place. Simply slide the large end of the USB cable into the power adapter body (it will fit in only one direction).

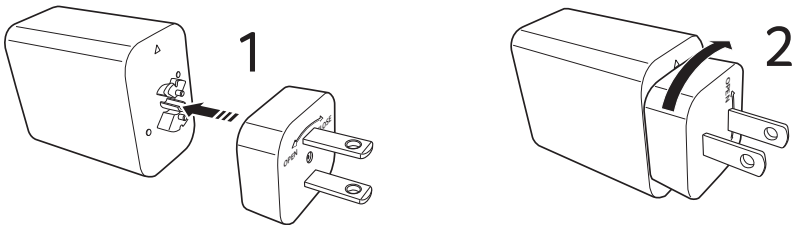

Connecting power

Connect the power connector to your tablet and plug the AC adapter into any AC outlet.

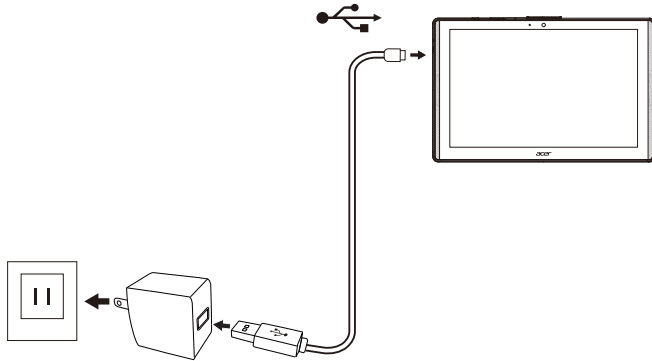

Warning

Only use an Acer-approved adapter to charge your device.



Note

It is normal for the tablet surface to become warm during charging or long periods of use.

USING YOUR TABLET

Using the touchscreen

Your tablet uses a touchscreen for selecting items and entering information. Use your finger to tap the screen.

Tap: Touch the screen once to open items and select options.

Swipe: Quickly swipe your finger across the screen to switch screens or open lists of options or information.

Drag: Hold your finger on the screen and drag across the screen to select text and images.

Tap and hold: Tap and hold an item to see a menu of actions for that item.

Scroll: To scroll up or down the screen, simply drag your finger up or down the screen in the direction that you want to scroll.

The Home screen

When you start your tablet, or wake it from power saving, it will display the *Home screen*. This screen gives you quick access to apps ("applications"), widgets, and folders. **See [Moving an app or folder on page 19](#)**.



Note

When you first see the Home screen, and your tablet is connected to the Internet, it will download a selection of recommended, optional apps. These may be deleted, as with any other downloaded app.

Folders are groups of apps that occupy one space on a *Home screen*. **See [Adding folders to a Home screen on page 20](#)**.

Widgets provide special functions, quick shortcuts to special app features, or serve as small apps that display constantly-updated information (like the time and weather). Many apps provide widgets, while some apps provide only a widget, and must be added and used from a Home screen. **See [Adding widgets to a Home screen on page 21](#)**.

Using the Home screens

The *Home screen* provides controls and information.

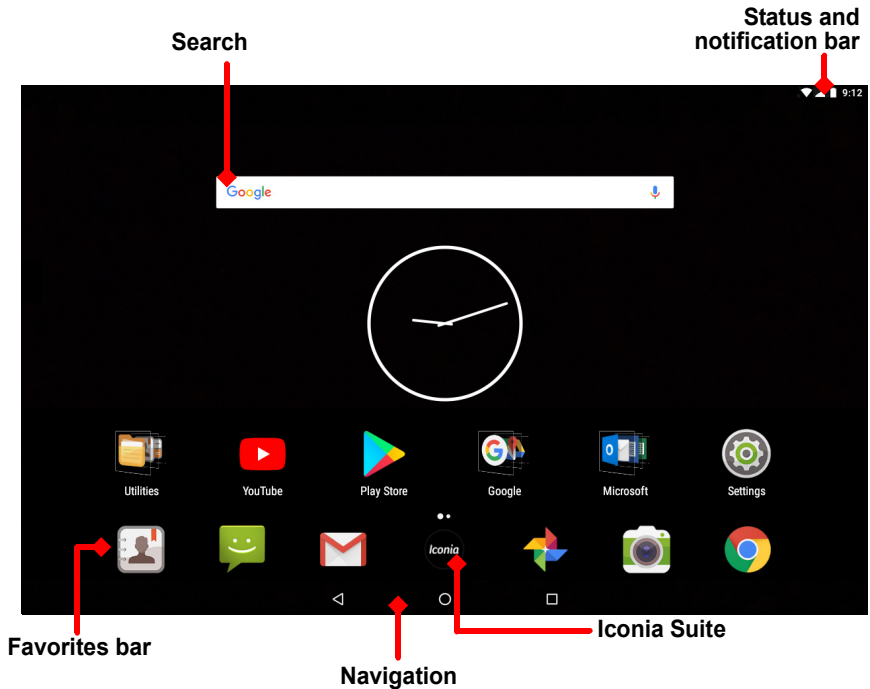

Note

Bundled apps differ depending on region and configuration.

Swipe the *Home screen* left to see most apps installed on your tablet. If you need more space, you can extend the *Home screen* to give you more screens to add app icons or widgets. To add additional screens, tap, hold, and then drag an icon to the right edge of the screen. **See [Moving an app or folder on page 19](#) and [Adding widgets to a Home screen on page 21](#).**



Note

Removing or moving all apps and widgets from a Home screen will automatically remove that Home screen as well.

Navigation

To navigate through menus and options, three (or more) icons are shown at the bottom of the screen.



Back

Tap this icon to go to the previous page, or to go up one level in a menu. This icon may be replaced with the *hide* icon in certain cases (e.g. when the keyboard is displayed). In this case, tapping the icon minimizes the keyboard.



Home

Tap this icon to go directly to the *Home* screen. Tap and hold to open *Google search*.

Overview / Recent

Tap this icon to see recently opened apps in your tablet's *Overview* screen. Tap an app to open it. Tap anywhere on the screen to return to the *Home* screen.

Previous app

Double tap the *Overview* icon to switch directly to the previously used app.

Split-screen mode

If you are using a compatible app, tap and hold the *Overview* icon to enter split-screen mode. [See Split-screen mode on page 18.](#)



Favorites bar

The *Favorites bar* is visible on any *Home* screen and holds apps you frequently use. To remove an app from the bar, simply tap and hold the app and drag it away. To fill the gap with an app of your choice, [see Moving an app or folder on page 19.](#)



Iconia Suite

The Iconia Suite icon is in the middle of the Favorites bar.

Tap the **Iconia** icon for more information on installed apps and features.

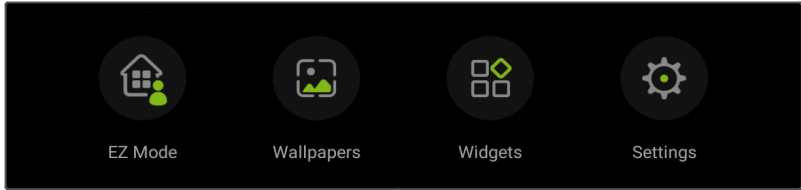

Note

When you first open the Iconia Suite drawer, you will see a summary of the Iconia apps or features. Swipe left to see all the descriptions or tap **Skip** to continue. Tap the **i** in the top-right corner to see the descriptions again.

EZ Mode

Set up your tablet with multiple profiles so you can share your device with your family and friends. EZ Mode helps you to manage and schedule access to apps for each profile.

Wallpapers

Change the image for the screen background. **See Changing the wallpaper on page 22.**

Widgets

Add a widget to the screen. **See Adding widgets to a Home screen on page 21.**

Settings

Open *Layout* settings for your tablet.

Access requests

When you first open some apps, or use certain functions, your tablet will ask for permission to access some features or information.

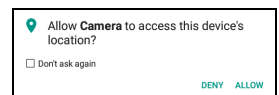

To allow the app to fully function tap **Allow** or **OK**, but if you do not want to share some information you can choose to **Cancel** or **Deny**

access; however this may cause some apps to function incorrectly. To change permissions later, open the app information in **Settings** > **Apps**, then tap **Permissions** to turn permissions on or off.

Search

Search enables you to use a single, quick search to locate a variety of information on the internet and on your tablet. To use *Search*, simply tap  in the search bar and type your query.







Note

In order to search or browse the internet, you must be connected to a wireless network. See [Going online on page 29](#).

Searching on the internet

As you type, a list displays search suggestions. Based on the words you enter, these suggestions try to help you quickly access what you are looking for and may include the following:

-  A previous search you performed on any device while you were logged into your Google account and performed a Google search;
-  A new internet search suggesting what you might be looking for;
-  A specific website address.

If what you're looking for appears in the suggestions list, simply tap it. Otherwise, tap  on the keyboard.

Tap a category at the top of the results screen to filter the search results to show just *Images*, *News*, or other type of result.

Searching on your tablet

Tablet search results are shown below the internet search suggestions. These suggestions are taken from sources such as the names of apps installed on your tablet, settings, media files from Google Play apps, contacts, bookmarks, and browsing history.



Note

*You can choose what information is included in tablet searches. Swipe right from the Home Screen to open the Google App screen and tap the Menu icon  in the top-left corner of the screen. Then tap **Settings** > **Tablet search**.*

Voice search and "OK Google"

With voice actions, you can send text messages, place calls, send emails, find directions, search the internet and even send a note to yourself using your voice. Say "OK Google" or swipe left on the *Home screen* and tap **Voice Search**. For information on using voice search in the *Chrome* app, [see Voice Search in Chrome on page 32](#).



Note

Voice Search is available only in selected regions.

Status and notification area

Status and notification icons are shown at the top of the screen. The top-right corner displays status information such as the time, battery status, and connectivity. The top-left corner displays event notifications, such as new message alerts.



Wi-Fi and cellular signal strength

Battery charge status

Time

Swipe down from the top of the screen to display Quick Settings shortcuts, and notification details such as current downloads and media controls when music is playing.

Tap a shortcut to see more information, or toggle the feature if more information is not available. Tap and hold a shortcut to open appropriate *Settings*.



Swipe down again to display the full list of *Quick Settings* tiles. To see the *Quick Settings* tiles with one swipe, swipe down with two fingers.

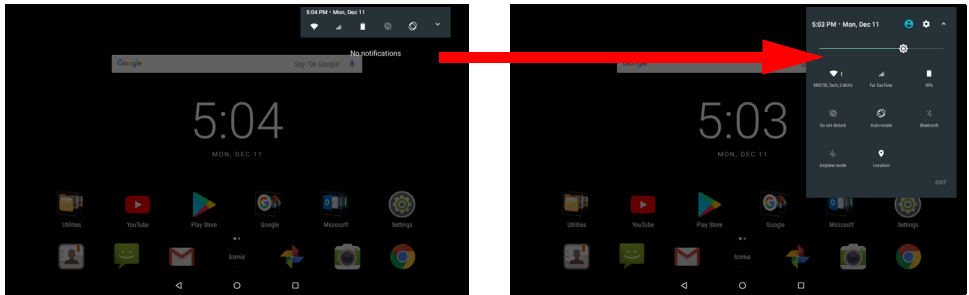

Quick Settings tiles

Icon	Name	Description
	Brightness	Slide to adjust the screen's brightness.
	Wi-Fi	Tap to toggle Wi-Fi on and display Wi-Fi settings. Small "up" and "down" arrows mean information is being transmitted.
	Battery usage	Tap to see battery charge levels and access <i>Battery Saver</i> settings.
	Do not disturb	Tap to silence some or all notifications or alarms.
	SIM (LTE models only)	Tap to enable and disable the cellular connection. If Data connection is disabled, you will not be able to use cellular networks.
	Auto rotate	Tap to toggle automatic screen rotation on and off.
	Bluetooth	Tap to toggle Bluetooth on and open Bluetooth settings.
	Airplane mode	Tap to toggle Airplane mode on and off. When on, wireless connectivity is turned off unless you choose to turn a network on again.
	Location	Tap to toggle your device's location services on and off.



Note

Tap and hold a tile to open related settings.

Edit

Tap **Edit** to see more *Quick Settings* tiles. Tap and hold a tile and drag to add, remove or move it. The first five tiles are visible in the *Quick Settings* shortcuts.

Notifications

Tap a notification to open the appropriate app; tap and hold a notification to see additional controls.

Split-screen mode

If you are using a compatible app (not from the *Home screen*), tap and hold the *Overview* icon to enter split-screen mode. The app that is open will move to the left (or top) of the screen and the *Overview* of recently opened apps will open on the other side. Tap on a compatible app to view and use both at the same time.

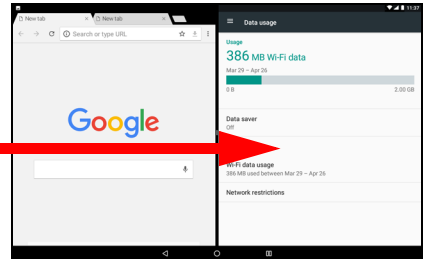
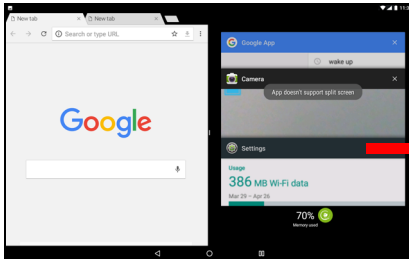

Note

You may view two tabs from Chrome in split-screen mode. Open Chrome with more than one tab while in split-screen mode; the **Menu** ☰ icon and select **Move to other window**.

Drag the divider to increase the size of one window to two-thirds of the screen.

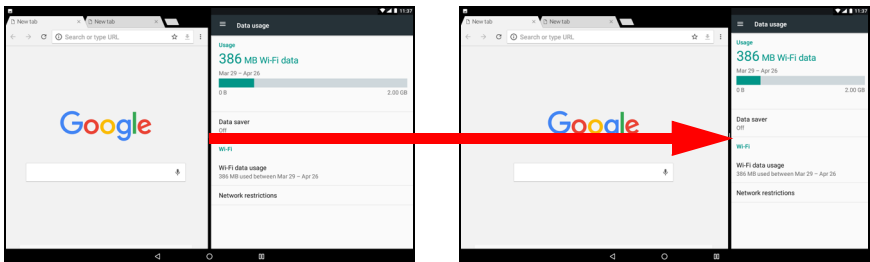

Drag the divider to the edge of the screen or tap and hold the split-screen icon to exit split-screen mode.



Note

In certain apps, you may tap and hold selected text or an image and drag it to the other app.

Personalizing Home screens

You can personalize your *Home screen* by moving apps, adding or removing widgets, creating folders and by changing the wallpaper.

Moving an app or folder

Tap and hold an app or folder you want to move. To view information about the app, drag it to **App info** at the top of the screen. Otherwise, release your finger to place the app.

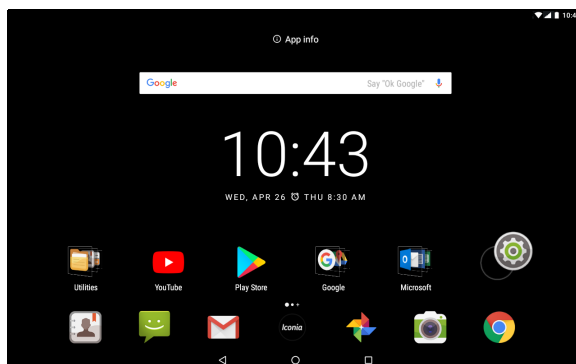

To place the app on a different *Home screen*, do the following:

1. Slide your finger to the right or left side of the screen.



Note

You may not place icons to the left of the main *Home screen*.

2. Hold the app there until you are on the desired *Home screen*.
3. Release your finger to place the app.

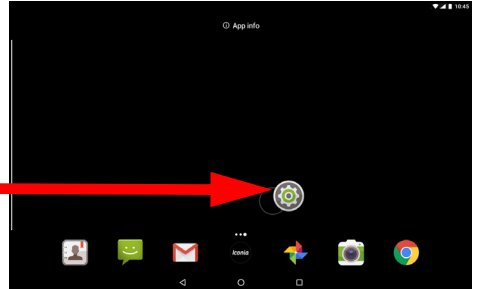
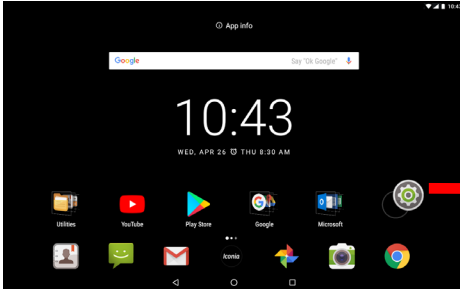

Adding folders to a Home screen

You can also add folders to your *Home screen*. To create a new folder drag and drop an app icon onto another app icon. This will create an "Unnamed Folder". Tap the folder icon and then tap the name of the folder to rename it.

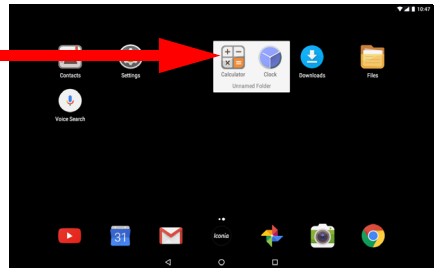
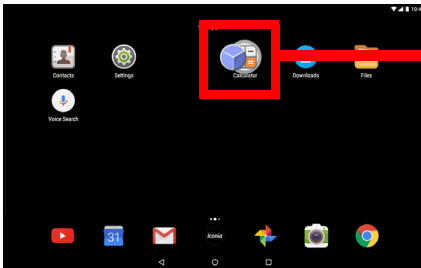

To remove an app shortcut from a folder, tap on the folder icon to display the apps inside and then tap and hold the app icon that you want to remove. Drag and drop the icon to a new position. If you remove all but one shortcut, the folder will be removed.

Installing apps from a Home screen

To remove a downloaded app from the *Home* screen, tap and hold the item until the **Uninstall** option appears at the top of the screen. Simply drag the item to the **Uninstall** option and tap **OK**.



Note

You may only uninstall downloaded apps. Apps that were preinstalled on your tablet may not be removed.

Adding widgets to a Home screen

Tap and hold any open space on a *Home* screen, then tap **Widgets**. To move a widget to the *Home* screen, tap and hold an item until it is selected. The *Home* screen will open. Drag the item to any free area on the screen.

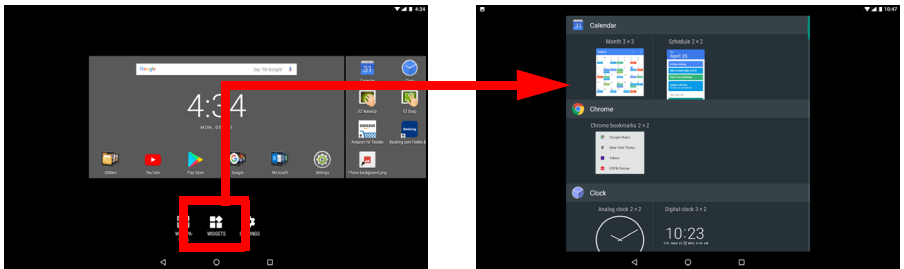

If you wish to place a widget on an extended *Home* screen, do the following:

1. Slide your finger to the right or left side of the screen.



Note

You may not place widgets to the left of the main Home screen.

2. Hold the widget there until you are on the desired *Home* screen.
3. Release your finger to place the widget.

Removing widgets from a Home screen

To remove an item from the *Home* screen, tap and hold the item until the **Remove** option appears at the top of the screen. Simply drag the item to the **Remove** option.



Changing the wallpaper

Tap and hold any open space on the *Home screen* and tap **Wallpapers**. To choose from pre-selected background images, tap an image at the bottom of the screen and tap **Set wallpaper** in the top-left corner of the screen.

To choose an image to use as wallpaper tap **My photos** then select a location that contains images, such as *Google Drive*, *Gallery*, and others.

If the list of locations is not visible, tap the **Menu icon** ☰ .

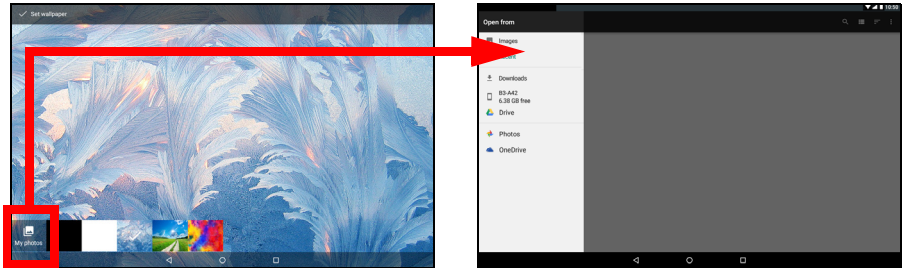

The virtual keyboard

When you tap a text box to enter text, a virtual keyboard will appear. Simply tap on keys to enter text.

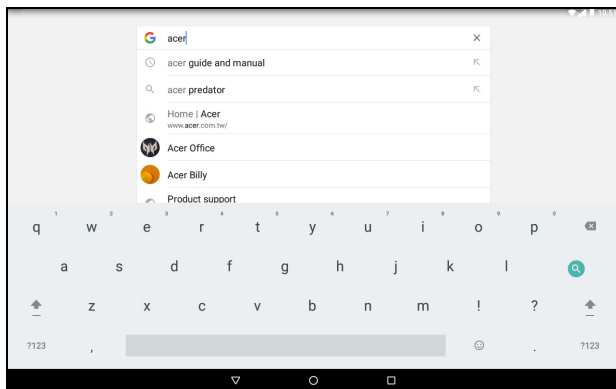

Note

The layout of the keyboard (and some button icons) vary slightly, depending on the app and information that is required.

Tap the **?123** button to see numbers and special characters, and then tap the **=\<** key to see more options. Tap and hold a key to select alternative characters (if available for that key), such as letters with accents or related symbols.

Changing Google keyboard settings

To use a different keyboard language or change settings, swipe left to the list of apps and tap **Settings**. Tap **Languages & input** and tap the option you want to modify.

Predictive text or auto correction

The Google keyboard can provide predictive text input. As you tap the letters of a word, a selection of words are displayed above the keyboard that continue the sequence of letters tapped, or are a close match allowing for errors. The word list changes after every key press. If the word you need is displayed, you can tap on it to insert it into your text.

To turn predictive text on or off with the Google keyboard, swipe left to the list of apps and tap **Settings**. Tap **Languages & input** and under *Keyboard & input methods*, tap **Virtual keyboard > Google Keyboard > Text correction**. Tap **Show suggestions** to toggle this feature on or off.



Note

Predictive text and auto correction not supported in all apps.

Editing text

You can select and edit text in certain apps, such as text you have entered in a text field. Selected text can be cut or copied and later pasted within the same app, or to a different app.



Note

Certain apps may not support text selection, or only support it in certain areas. Other apps may offer specialized commands to select text.

Selecting text

To select text that you want to cut, copy, delete or replace:

1. Tap the text you want to select. If you can select this text, a cursor is inserted below the text.
2. Tap and hold the text or word you want to select. The selected text is highlighted, with a tab at each end of the selection.
3. Drag either tab to expand or reduce the amount of selected text, or tap **SELECT ALL**.
4. To cut or copy the text, tap the **CUT** or **COPY** button.

Inserting text

To type new text or add text that you have copied:

1. Tap where you want to insert text. If you can select this text, a cursor is inserted below the text. To replace a word, double tap the word. In both cases, if you previously copied text, a PASTE button displays.
2. If the cursor is not in the desired position, simply drag it to the correct position.



3. Modify the text by typing or deleting text or tapping the PASTE button.

Setting an alarm

There are two predefined alarms on your tablet by default. To add or edit alarm settings, open **Clock** from the *Home Screen*, then tap ⌚.

Tap the ON/OFF switch next to a preset alarm to turn it on or off or tap  to create a new alarm.

Tap a preset alarm to edit it. You can:

- Set the alarm time.
- Give it a memo/name (e.g., "Work").

- Set which days to repeat the alarm.
- Set a ringtone.

Tap  to delete an alarm.

Waking your tablet

If the screen is off and the tablet does not react to any taps on the screen, then it has been locked and is in sleep mode.

To wake your tablet, press the power button. If you have set a Screen Lock, your tablet will display the *Lock* screen. To unlock the screen, swipe up from the bottom of the screen.

Security Options

For additional security, you may set a code or number that must be entered to access the tablet, such as an unlock pattern (a set of dots that must be swiped in the correct order) or a PIN. Swipe left to the list of apps and tap **Settings** > **Security** > **Screen lock**. If you forget your unlock settings, please refer to [Unlock pattern, PIN, or password on page 47](#).

Shutting down your tablet

If you won't use your tablet for an extended period of time, turn it off to save battery power. To turn off your tablet (even when locked), press and hold the power button until a menu displays (about one second). Tap **Power off** and confirm the shut down. To force a shutdown, press and hold the power button until the tablet shuts down (about four seconds).



Note

If your device's battery gets too hot, you will be notified and advised to turn off the device. If you fail to turn it off, it will shut down automatically.

CONNECTING DEVICES TO YOUR TABLET

Connecting to AC power

See [Charging your tablet](#) on page 9

Inserting a microSD card

You may install a microSD card to expand your device's storage space. Ensure that the microSD card is inserted all the way into the card slot.



Note

Your tablet only supports microSD cards that use the FAT, FAT32, exFAT, and NTFS file systems.

To check card capacity, open **Settings > Storage & USB**. Your card's current capacity is listed under *SD card*.

Transferring files between your tablet and a PC

Your tablet and any connected storage devices can be accessed from a PC with a USB connection.

Connecting to a PC as a USB storage device

If you wish to transfer information between your device and your computer (either the microSD card in your device or the device's internal memory), you can connect your device to a PC using the supplied USB cable.

1. Plug the USB sync cable into the micro USB connector on your device.
2. Plug the USB client connector into an available USB port on your computer.

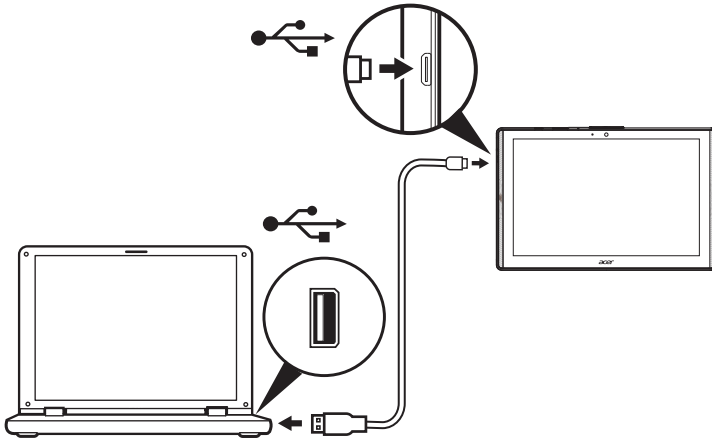

Your device will now be available as a drive in your computer's file explorer.

For USB options, swipe down from the top of the screen to display the notification area and tap **USB for file transfer** to choose whether to *Transfer files* (the recommended option) or *Transfer photos (PTP)*.

Connecting a Bluetooth device

To connect to a Bluetooth device, you must first pair the devices. To do so, do the following:

1. Open **Settings**, then under *Wireless & networks* tap **Bluetooth**.
2. Turn Bluetooth on and the tablet instantly starts scanning for nearby Bluetooth devices.
3. Tap the device you want to connect to and follow any on-screen instructions.

After the initial pairing, you only need to ensure your tablet's Bluetooth is on and the device is on to connect the two. For more information on connecting to another Bluetooth device, see the device's operating instructions.

Only A2DP stereo headsets (playback only, no microphone) are supported.



Note

*Please check for updates to the tablet's software which may add support for additional Bluetooth devices (open **Settings** > **About tablet** > **System updates** > **CHECK NOW**).*

Accessories

For a complete list of accessories, visit store.acer.com.

GOING ONLINE

Managing Wi-Fi connections

If you did not connect to a Wi-Fi network when you first started your tablet, or want to connect to a new network, swipe left to the list of apps and tap **Settings** > **Wi-Fi** to manage your connection settings. Alternatively, swipe down from the top of the screen and tap the Wi-Fi button to toggle on and off the Wi-Fi connection.

If Wi-Fi is not on, tap the Wi-Fi switch to **On** and wait for your tablet to detect nearby networks. Tap the name of your network and enter a security password, if needed.

Data saver (background data)

The *Data Usage* section shows how much data has been transmitted to your tablet, either in total or for each app. This information is useful if you are using a metered service.

If an app is using too much data, or you need to control how your data service is used, open **Settings**, then **Data Usage**, and turn *Data Saver* on. Tap to see a list of apps installed on your device, you may disable background data for individual apps. An app controlled by the *Data Saver* will only be able to access to a data connection when you're actively using the app.



Note

Blocking background data may cause some apps to stop working correctly. For example, background data is required to make regular checks for updates, useful for email or messenger apps.

Browsing the internet

In order to browse the internet with your tablet, you must be connected to a network with a connection to the internet.

Using the browser

To start browsing, tap the **Chrome** icon on the *Home screen*. To enter a website address, tap the address box at the top of the page. Enter the address using the keyboard and tap .

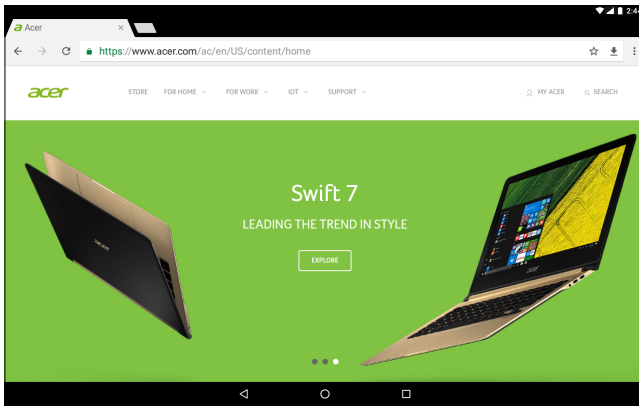

To navigate forward and backward in your browser's history, tap the arrow icons. To adjust browser settings and perform other tasks, tap the *Menu*  icon.

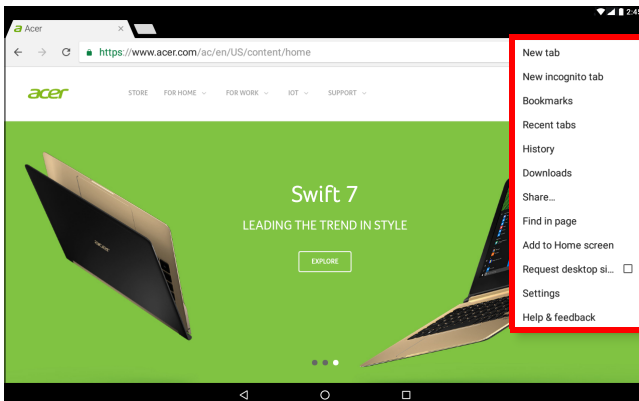

Chrome enables you to open multiple tabs. When a page is open, tap the small **New tab** button. Simply tap one of the open tabs across the top of the screen to switch pages.



Google services



Note

Apps may not be available in all countries and regions. You must activate a Google account before using Google services. The first time you access Google services, read and accept the Terms of Service. The contents and design of Google Play varies by region. For example, in some regions, you can also browse and purchase movies, books, magazines, or music. Updates may add new categories or change how to navigate Google Play at any time.

Setting up your Google email



1. Make sure your tablet is connected to the internet.
2. Open **Gmail** from the *Home screen*.

If you did not enter a *Gmail* account address and password when you first started your tablet, follow the instructions.

The combined inbox allows you to view emails from multiple accounts in a single inbox.

The *Gmail* app may also access email from most popular email providers. To add an account, tap *Menu* ≡ then **Settings** and select **Add account**. Select the type of account, then enter your email address and tap **Next** to automatically connect to your account. If your account requires more information, tap **Manual setup** instead.

Composing an email

1. Make sure your tablet is connected to the internet.
2. Open **Gmail** from the *Home* screen.
3. Tap .
4. Enter the recipient's email address, the subject and message.
5. When you have finished composing your message, tap .

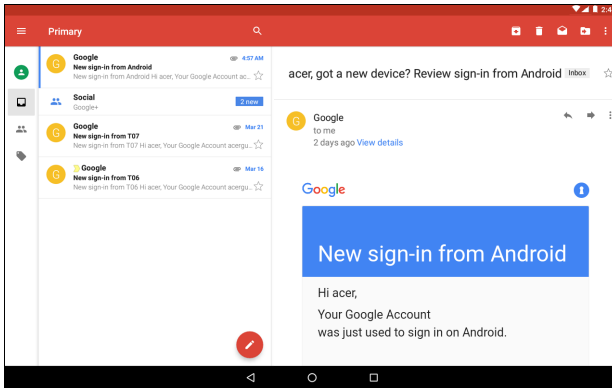

Voice Search in Chrome



Note

Voice Search is available only in selected regions.

With voice actions, you can send emails, find directions to locations, search the internet and even send a note to yourself using your own voice. In *Chrome*, tap the microphone icon in the address bar. If this is the first time you have used this function, tap **Allow**. When the **Speak now** prompt displays, state your command or query.

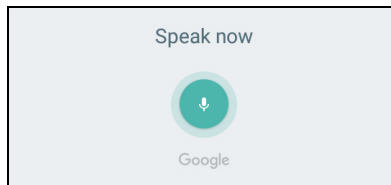

Google Play

Tap **Google Play** from the *Home screen*. Here you can obtain a variety of add-on programs and apps to enhance the functionality of your tablet.

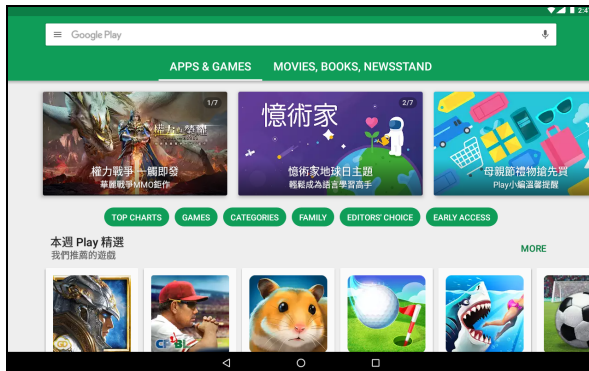

The contents and design of Google Play varies by region. For example, in some regions, you can also browse and purchase movies, books, magazines, or music. Updates may add new categories or change how to navigate Google Play at any time.

You can browse Google Play by category or tap the search icon to search for a specific app.

Once you have selected an app, tap **Install** to download and install the app. Tap **ACCEPT** to proceed with the installation.

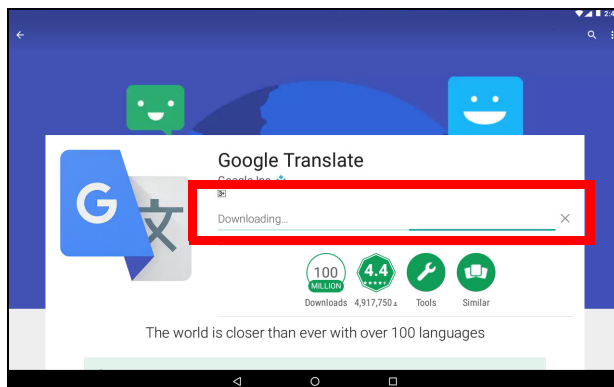

You may keep track of the download progress from both the app's page and your device's notification area.

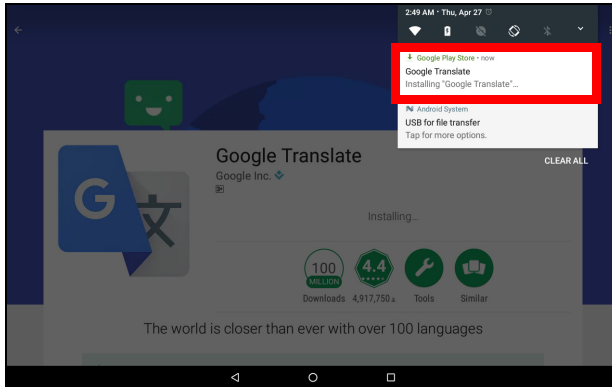

Important

Some apps may require payment before you can download them. Add a payment method in order to pay for these apps, such as redeeming a Google Play gift card or adding credit card details.

Using downloaded apps

Once you've downloaded and installed an app, you may find it in the *Home screen*. Some apps may be automatically added to an existing folder. For example, apps from Google may be added to the Google folder.

Certain apps provide both an app and widget, or only provide a widget (with no app shortcut). [See Personalizing Home screens on page 19.](#)

Uninstalling downloaded apps

If you do not find it useful, you may uninstall a downloaded app. [See Uninstalling an app on page 43.](#)

Google Hangouts

Google Hangout allows you to message a friend or hold group conversations over audio and video.

Tap **Hangouts** in the Google folder on the *Home* screen. You will see a list of your contacts connected to *Hangouts* services. Tap a contact to open a chat session. After you have connected, you can open a video chat session.

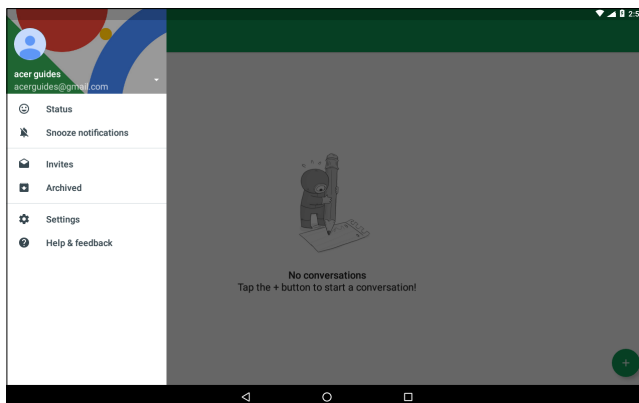

USING THE CAMERA AND VIDEO RECORDER

Your tablet features two cameras (front- and rear-facing). This section will take you through all the steps in taking photos and videos with your tablet. To activate the camera or video recorder, tap **Camera** on the *Home screen*.



Note

You can only save photos and videos to internal memory.

Camera/video icons and indicators

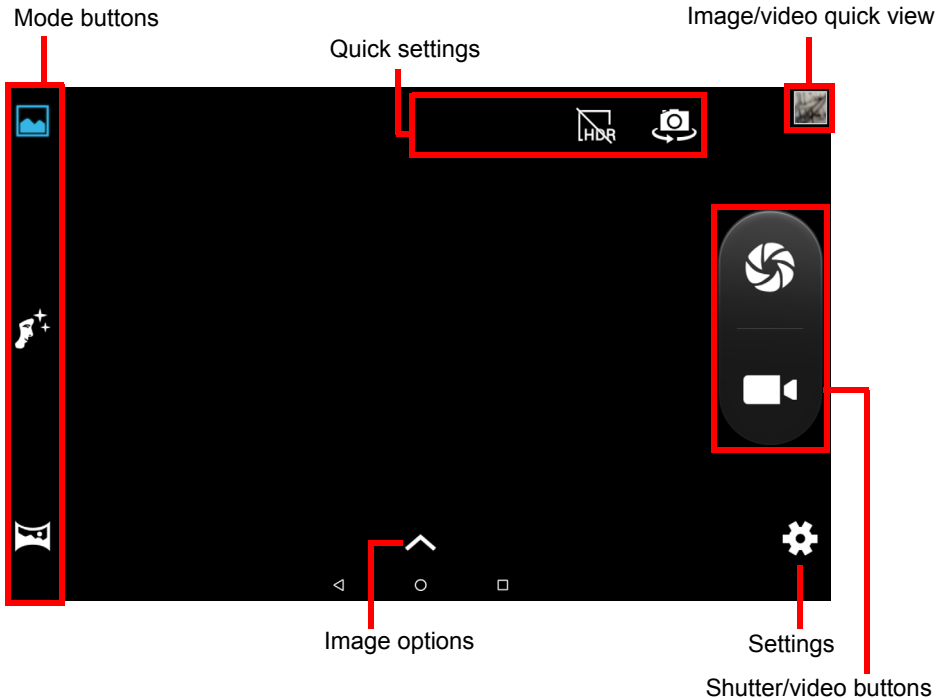

Mode buttons: Tap an icon to select one of the picture modes: *Normal*, *Face Beauty*, or *Panorama*.

Quick Settings: Tap an icon to turn *HDR* on or off, or to switch between the front and rear cameras.

Settings: Tap the *Settings* icon to change general, camera, and video settings.

Image Options: Tap the *arrow* icon to rapidly change settings for the selected mode: *Exposure*, *Color effect*, *White balance*, and *Scene mode*.

Shutter/Image buttons: Tap the shutter button to take a photo. Tap the *camera* button to begin recording. While recording, you are unable to access camera/video settings. Tap the camera again to stop filming.

Zoom: To zoom in, reverse pinch the screen. To zoom out, pinch the screen.

For more information about modes, settings and options, [see Camera and video options on page 38](#).

Taking a photo

1. Ensure the options are set to your preferences.
2. Frame your subject and steady your tablet.
3. Zoom in or out as needed.





Note

When zooming, the image on the screen does not represent the quality of the final image.

4. Tap  to take the photo.



Recording a video

1. Ensure the options described above are set to your preferences.
2. Frame your subject and steady your tablet and zoom in or out as needed.
3. Tap  to begin recording.
4. Tap  to stop recording.

Viewing photos and videos

After you have taken your photo or video, it is automatically saved to internal memory. You can quickly view it by swiping in from the right side of the screen. Alternatively, tap **Photos**, then look for *Camera*.

Look for the photo or video you want to view (videos are marked with a small play symbol). Tap the image once to enlarge it; and tap it again to zoom into the image.

You can share photos using various services and edit the image using various options. Tap  to see which sharing options are available for the file or tap  to display image editing options.

Camera and video options

Mode

Change the way your camera takes pictures:

Mode	Description
Normal	Take a single picture.
Face Beauty	Add skin smoothing effects to the picture.
Panorama	Take a series of images that will be combined to make a single extra-wide picture.

Quick settings

Tap an icon to change turn *HDR* on or off, or to switch between the front and rear cameras.

Settings

Settings are divided into three sections: *General*, *Camera* and *Video*.

General

Adjust general image settings with these options:

Setting	Options
GPS location info	Set if the location (from GPS) is stored in the image information. Certain apps can use this to show where the photo was taken.
Face beauty	Multi-face mode / off
Exposure	0 / +1 / +2
Scene mode	Auto / Night / Sunset
White balance	Auto / Incandescent / Daylight

Setting	Options
Image properties	Sharpness / Hue / Saturation / Brightness / Contrast
Anti-flicker	Auto / Disabled / 50 Hz / 60 Hz
Restore defaults	Restore all Settings to their original values.

Camera

Adjust camera image settings with these options:

Setting	Options
Zero shutter delay	On / off
Anit-shake	On / off
Face detection	On / off
Auto scene detection	On / off
Self timer	Off / 2 seconds / 10 seconds
Capture number	40 shots / 99 shots (for <i>Continuous shot</i>)
Picture size	1 megapixel / 5 megapixels
Preview size	Full screen / Standard (4:3)
ISO	Auto / 100 / 200 / 400 / 800 / 1600

Video

Adjust video settings with these options:

Setting	Options
Noise reduction	On / off
EIS	On / off (electronic image stabilization)
Microphone	On / off
Audio mode	Normal / Meeting
Video quality	Fine / Medium / High

ADVANCED SETTINGS

To access **Settings**, swipe left on the *Home screen* and tap **Settings**.

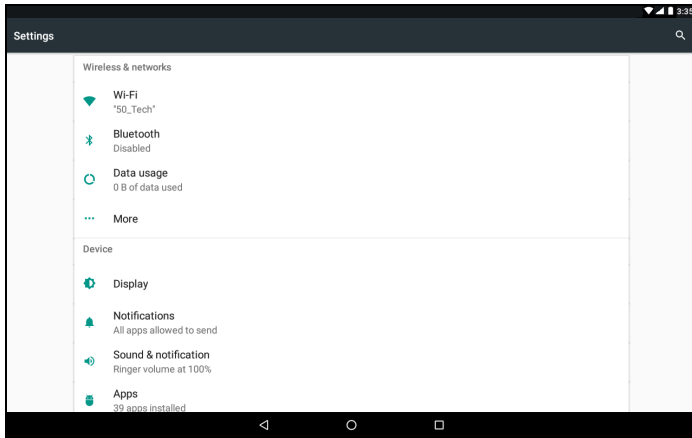

To quickly navigate with a list of main categories, swipe in from the left of the screen.

Wireless & Networks

Wi-Fi

Displays all available wireless networks. Turn the Wi-Fi function on or off. Wireless networks may require a password.

Tap the *Settings* icon in the top-right corner for additional options.

Bluetooth

Displays all available devices with which you can use Bluetooth. You can switch Bluetooth on or off, rename the device name used by the tablet, and show received files.

To connect to a device, tap the device in the list of available devices. You may be asked to enter a PIN on one or both devices to establish the connection.

Data Usage (background data)

The *Data Usage* section shows how much data has been transmitted to your tablet, either in total or for each app. This information is useful if you are using a metered service.

If an app is using too much data, or you need to control how your data service is used, open the **Data Usage** menu, and turn *Data Saver* on. Tap to see a list of apps installed on your device, you may disable background data for individual apps. An app controlled by the *Data Saver* will only be able to access to a data connection when you're actively using the app.



Note

Blocking background data may cause some apps to stop working correctly. For example, background data is required to make regular checks for updates, useful for email or messenger apps.

More...

Putting your tablet in Airplane mode

You can enter Airplane mode (also known as 'flight mode') to turn off network and Bluetooth functions and use your tablet during a flight. Check with your airline to confirm which devices are permitted on board.

Always follow instructions, such as switching your tablet off during takeoff and landing as it may interfere with aircraft electronic systems.



Note

When Airplane mode is active, the ✈ icon is displayed in the status area.

To turn Airplane mode on or off, tap **Settings**, then under **Wireless & Networks** tap **More > Airplane mode**.

Alternatively, swipe down from the top of the screen to use the airplane mode tile.

Virtual Private Network (VPN)

This option enables you to connect to a private network, such as a secure work or office environment.

To add a VPN open **Settings**, then under **Wireless & Networks** tap **More > VPN**. In the top-right corner of the screen, tap the plus sign.

Device

Display

You can adjust your tablet screen settings. Open **Settings > Display**.

Item	Description
MiraVision	Optimizes the picture quality with color tuning and color enhancement.
Brightness level	Adjusts screen brightness.
Bluelight Shield	Protects your eyes by reducing blue-light emissions from the screen.
Wallpaper	Set the <i>Home screen</i> and <i>Lock screen</i> background image.
Sleep	Configure how long the tablet is idle before it goes to sleep mode.
Screen saver	Controls what happens when the tablet is docked and/or sleeping.
Font size	Sets the font size so either more text is visible or the text is easier to read.
Display size	Sets the size of icons and text on the screen.
When device is rotated	Choose to automatically rotate the screen's contents when the device is rotated or to keep the current screen's orientation even when the device is rotated. <i>You can enable or disable the screen rotation function by swiping down from the top of the screen and tapping the Auto-rotate tile.</i>
Cast	Mirrors your tablets display on a compatible monitor or display. <i>You must pair your tablet to a display or dongle before options are available. See the instructions that came with your display or dongle to pair.</i>

Notifications

Stop apps creating notifications, or restrict how and when the notifications may be seen.

Sound & notification

Adjust the volume of media, alarms and notifications on your tablet, and change or mute ringtones and other sounds.

You may also adjust the volume of media, alarms and notifications using the volume buttons on the edge of the tablet.

Apps

Closing an application

To close an active app, open the *Overview*  screen. Swipe up or down to find the app you wish to close. Swipe the app to the right to close the app.

Forcing an app to stop

If an app is causing problems on your tablet, you can force it to stop. Open **Settings**, then select **Apps**. Tap the app you wish to stop, tap **FORCE STOP** and confirm.

Uninstalling an app

You can remove apps installed on your tablet to free up extra storage memory. Tap the app icon from the *Home screen* and drag it into the **Uninstall** area at the top of the screen.



Note

You cannot uninstall apps that were pre-loaded on your tablet.

Alternatively, open **Settings**, then select **Apps**. Tap the app you wish to uninstall, tap **UNINSTALL** and confirm.



Warning

You may also choose to *Disable* apps that were preinstalled on your tablet, but this is not recommended and many apps are essential for your tablet to work correctly.

**Important**

You should only Force Stop or Disable apps if you are familiar with the Android™ operating system.

Personal

Accounts and synchronization

You can sync your calendar, email and contacts on your tablet, and access the latest updates on all your Android devices. Open **Settings**. Under *Personal*, tap **Accounts**. Then tap the appropriate account to access the synchronization settings.

To add a new account, tap **Add account**. Select the type of account and then follow the instructions.

Google Sync

In your Google account, you can set synchronization for Google products including Browser, Calendar, Gmail, Google Photos, and others. From the *Settings* menu, tap **Accounts** > **Google** and under *Accounts*, tap your account name (your Gmail email address).

Tap the toggle next to the item to turn auto-sync on or off.

To manually synchronize an item, make sure the item is 'on', tap the *Menu*  icon and then tap **Sync now**.

Multiple Google accounts

If you have multiple Google accounts, such as separate accounts for personal and business contacts, you can access and synchronize them from the *Accounts* settings section. Open **Settings** > **Accounts** > **Add account**.

Users

To create separate user accounts or profiles on your tablet, open **Settings** > **Users**. The 'Owner' may create a *User* account, with their own email address, apps and content, or a *Restricted profile* that has access to a limited version of the Owner's account.

Users or profiles may sign in from the Lock screen or notification bar.

Changing language and text options

To set your location and language input preferences open **Settings > Languages & input**.

System

Setting the date and time

To set the date and time, open **Settings > Date & time**.



Note

*If you travel frequently or live in an area that uses daylight saving time, and have mobile network access, activate **Automatic time zone**. Your tablet will set the date and time based on information it receives from the network.*

To set an alarm see **Setting an alarm on page 24**.

Updating your tablet's operating system

Your tablet can download and install system updates, adding support for new devices or expanding software options.

To check for operating system, or 'firmware', updates, open **Settings > About tablet > System updates > CHECK NOW**.



Note

Downloading new firmware can take up to 40 minutes, depending on your network speed. Do not press the power button or access your tablet in any way during a system upgrade to prevent firmware installation failure.

Resetting your tablet

A data reset, or format, restores your tablet to factory settings.



Important

This will erase all your personal information, any contacts stored on your tablet and any programs you installed.

To perform a reset, open **Settings** then tap **Backup & reset > Factory data reset**; tap **RESET TABLET** and then **ERASE EVERYTHING**.

FAQ AND TROUBLESHOOTING

This section lists frequently asked questions that may arise during the use of your tablet, and gives easy answers and solutions to these questions.

Aspect	Question	Answer
Audio	Why is there no sound coming from the device?	If the headset is plugged into the device, the speaker is automatically shut off. Disconnect the headset. Check that the device volume setting is not muted. Check that the volume control is not at its lowest setting.
	Why do I have less storage than the specifications say?	A small amount of memory is reserved for system security.
Multimedia files	Why can't I view my picture files?	You may be trying to view an image that is not supported. Try a different app.
	Why can't I view my video files?	You may be trying to view a video that is not supported. Try a different app.
	Why can't I play my music files?	You may be trying to play a file that is not supported. Try a different app.
System information and performance	How do I check the OS version of my device?	Open Settings > About tablet to check the OS version (Kernel/build number) and other hardware and software information.
	Where can I find my serial number ID?	Open Settings > About tablet > Device Information .

Aspect	Question	Answer
Power	I couldn't turn on the device.	The battery power may be depleted. Recharge the device. See Charging your tablet on page 9 for more information.
Storage	How do I check memory status?	To check storage status, go to Settings > Storage .
	What do I do when my device's internal storage is full or almost full?	You may need to delete installed apps or move media files to the microSD card.
Unlock pattern, PIN, or password	I forgot my unlock pattern, PIN, or password.	You must reset and restore your tablet. If this option is not available, please contact your local Acer service center.
Heat	The tablet heats up when charging or operating for a long period.	It is normal for the device to heat up when charging. When charging is complete, it will return to its normal temperature. It is also normal for the tablet to heat up during long periods of use, such as watching a video or playing a game. All Acer tablets are factory-tested before release.

Other sources of help

For information on:	Refer to:
Up-to-date information regarding your tablet	www.acer.com
Service enquiries	support.acer.com

SPECIFICATIONS

Performance

- MTK MT8735 quad-core Cortex A53 1.3 GHz processor
- System memory:
 - 2 GB of LPDDR3 SDRAM
 - 16 GB of flash memory

Android 7.0 (Nougat) operating system

Display

- 10.1" HD IPS LCD integrated multi-touch screen
- 1280 x 800 resolution

Multimedia

- Two built-in stereo speakers
- Built-in microphone

USB connector

- Micro USB port
- OTG support

Power

- DC power-in (10 W)

Connectivity

SIM support (1 x nano SIM)

- GSM / GPRS / EDGE: 850 / 900 / 1800 / 1900 MHz
- GPRS / EDGE: Multi-slot class 12
- WCDMA: 1, 2, 5 (2100 / 1900 / 850 MHz), upload up to 11.5 Mbps / download up to 42.2 Mbps

- LTE Cat.4, Band 1, 3, 7, 8, 20 (2100 / 1800 / 2600 / 900 / 800 MHz), upload up to 50 Mbps / download up to 150 Mbps
- Bluetooth 4.0
- 802.11a/b/g/n wireless LAN

Navigation

- GPS
- GLONASS support

Camera

- Front camera
 - 2-megapixel
 - 720p HD audio/video recording
- Rear camera
 - 5-megapixel
 - 1080p Full HD audio/video recording

Expansion

- Micro USB ports
- MicroSD card slot (SDXC, up to 128 GB)

Battery

- 22.4 Wh 6100 mAh 3.7 V 2-cell Li-ion battery pack
Battery life: Up to 9 hours (based on video playback test results)



Note

Length of battery operation will depend on power consumption which is based on system resource use. For example, constantly using the backlight or using power-demanding apps will shorten battery life between charges.

Dimensions

Height	167.5 mm
Width	259 mm
Thickness	9.15 mm
Weight	550 g

Environment

Temperature

Operating: 0° C to 35° C

Non-operating: -20° C to 60° C

Humidity (non-condensing)

Operating: 20% to 80%

Non-operating: 20% to 80%

TRADEMARK INFORMATION



For DTS patents, see <http://patents.dts.com>. Manufactured under license from DTS Licensing Limited. DTS, DTS-HD, the Symbol, & DTS or DTS-HD and the Symbol together are registered trademarks, and DTS-HD Premium Sound is a trademark of DTS, Inc. © DTS, Inc. All Rights Reserved.

GUIDELINES FOR SAFE BATTERY USAGE

Battery information

Do not use this product in a humid, wet and/or corrosive environment. Do not put, store or leave your product in or near a heat source, in a high temperature location, in strong direct sunlight, in a microwave oven or in a pressurized container, and do not expose it to temperatures over 60° C (140° F). Failure to follow these guidelines may cause the battery to leak acid, become hot, explode or ignite and cause injury and/or damage. Do not pierce, open or disassemble the battery. If the battery leaks and you come into contact with the leaked fluids, rinse thoroughly with water and seek medical attention immediately. For safety reasons, and to prolong the lifetime of the battery, charging will not occur at low (below 0° C/32° F) or high (over 45° C/113° F) temperatures.

The full performance of a new battery is achieved only after two or three complete charge and discharge cycles. The battery can be charged and discharged hundreds of times, but it will eventually wear out. When the talk and standby times are noticeably shorter than normal, buy a new battery. Use only manufacturer approved batteries, and recharge your battery only with manufacturer approved chargers designated for this device.

Unplug the charger from the electrical plug and the device when not in use. Do not leave a fully charged battery connected to the AC charger, since overcharging may shorten its lifetime. If left unused, a fully charged battery will lose its charge over time. If the battery is completely discharged, it may take a few minutes before the charging indicator appears on the display or before any calls can be made.

Use the battery only for its intended purpose. Never use any charger or battery that is damaged.

Do not short-circuit the battery. Accidental shortcircuiting can occur when a metallic object such as a coin, clip, or pen causes direct connection of the positive (+) and negative (-) terminals of the battery.

These look like metal strips on the battery. This might happen, for example, when you carry a spare battery in your pocket or purse. Short-circuiting the terminals may damage the battery or the connecting object.

Leaving the battery in hot or cold places, such as in a closed car in summer or winter conditions, will reduce the capacity and lifetime of the battery. Always try to keep the battery between 15° C and 25° C (59° F and 77° F). A device with a hot or cold battery may not work temporarily, even when the battery is fully charged. Battery performance is particularly limited in temperatures well below freezing.

Do not dispose of batteries in a fire as they may explode. Batteries may also explode if damaged. Dispose of batteries according to local regulations. Please recycle when possible. Do not dispose as household waste.

Replacing the battery

Replace the battery with the same type as that which came bundled with your product. Use of another battery may present a risk of fire or explosion.



Warning

Batteries may explode if not handled properly. Do not disassemble or dispose of them in fire. Keep them away from children. Follow local regulations when disposing of used batteries.

END USER LICENSE AGREEMENT

IMPORTANT - READ CAREFULLY: THIS END USER LICENSE AGREEMENT ("AGREEMENT") IS A LEGAL AGREEMENT BETWEEN YOU (EITHER AN INDIVIDUAL OR A SINGLE ENTITY), AND ACER INC. INCLUDING ITS SUBSIDIARIES ("ACER") FOR THE SOFTWARE (WHETHER PROVIDED BY ACER OR BY ACER'S LICENSORS OR SUPPLIERS) THAT ACCOMPANIES THIS AGREEMENT, INCLUDING ANY ASSOCIATED MEDIA, PRINTED MATERIALS AND RELATED USER ELECTRONIC DOCUMENTATION WHICH MAY BE BRANDED "ACER", "GATEWAY", "PACKARD BELL", OR "EMACHINES" ("SOFTWARE"). AGREEMENTS RELATING TO ANY OTHER PRODUCT OR TOPIC ARE NEITHER INTENDED NOR SHOULD THEY BE IMPLIED. BY INSTALLING THE ACCOMPANYING SOFTWARE OR ANY PORTION THEREOF, YOU AGREE TO BE BOUND BY THE TERMS AND CONDITIONS OF THIS AGREEMENT. IF YOU DO NOT AGREE TO ALL OF THE TERMS AND CONDITIONS OF THIS AGREEMENT, DO NOT CONTINUE THE INSTALLATION PROCESS AND IMMEDIATELY DELETE ALL INSTALLED FILES, IF ANY, OF THE ACCOMPANYING SOFTWARE FROM YOUR DEVICE.

IF YOU DO NOT HAVE A VALIDLY-LICENSED COPY OF THE APPLICABLE SOFTWARE, YOU ARE NOT AUTHORIZED TO INSTALL, COPY OR OTHERWISE USE THE SOFTWARE, AND HAVE NO RIGHTS UNDER THIS AGREEMENT.

The Software is protected by U.S. and international copyright laws and conventions as well as other intellectual property laws and treaties. The Software is licensed, not sold.

GRANT OF LICENSE

Acer grants to you the following non-exclusive and non-transferable rights with respect to the Software. Under this Agreement, you may:

1. Install and use the Software only on a single designated device. A separate license is required for each device on which the Software will be used;
2. Make one copy of the Software solely for backup or archival purposes;
3. Make one hard copy of any electronic documents included in the Software, provided that you receive the documents electronically.

RESTRICTIONS

You may NOT:

1. Use or copy the Software except as provided in this Agreement;
2. Rent or lease the Software to any third party;
3. Modify, adapt, or translate the Software in whole or in part;
4. Reverse engineer, decompile, or disassemble the Software or create derivative works based upon the Software;
5. Merge the Software with any other program or modify the Software, except for your personal use; and
6. Sublicense or otherwise make the Software available to third parties, except that you may, after prior written notification to Acer, transfer the Software as a whole to a third party so long as you do not retain any copies of the Software and such third party accepts the terms of this Agreement.
7. Transfer your rights under this Agreement to any third parties.
8. Export the Software in contravention of applicable export laws and regulations, or (i) sell, export, re-export, transfer, divert, disclose technical data, or dispose of, any Software to any

prohibited person, entity, or destination including, without limitation, Cuba, Iran, North Korea, Sudan and Syria; or (ii) use any Software for any use prohibited by the laws or regulations of the United States.

SUPPORT SERVICES

Acer is not obligated to provide technical or other support for the Software.

ACER LIVE UPDATE

Certain software contains elements that enable the use of the Acer Live Update service, which allows for updates for such software to be automatically downloaded and installed on your device. By installing the software, you hereby agree and consent that Acer (or its licensors) may automatically check the version of such software that you are using on your device and may provide upgrades to such software that may be automatically downloaded on to your device.

OWNERSHIP AND COPYRIGHT

Title, ownership rights and intellectual property rights in and to the Software and all copies thereof shall remain with Acer or Acer's licensors or suppliers (as applicable). You do not have or shall not gain any proprietary interest in the Software (including any modifications or copies made by or for you) or any related intellectual property rights. Title and related rights in the content accessed through the Software is the property of the applicable content owner and may be protected by applicable law. This license gives you no rights to such contents. You hereby agree:

1. Not to remove any copyright or other proprietary notices from the Software;
2. To reproduce all such notices on any authorized copies you make; and
3. To use best efforts to prevent any unauthorized copying of the Software.

TRADEMARKS

This Agreement does not grant to you any rights in connection with any trademarks or service marks of Acer or of Acer's licensors or suppliers.

DISCLAIMER OF WARRANTIES

TO THE MAXIMUM EXTENT PERMITTED BY APPLICABLE LAW, ACER, ITS SUPPLIERS, AND ITS LICENSORS, PROVIDE THE SOFTWARE "AS IS" AND WITH ALL FAULTS, AND HEREBY DISCLAIM ALL OTHER WARRANTIES AND CONDITIONS, EITHER EXPRESS, IMPLIED OR STATUTORY, INCLUDING, BUT NOT LIMITED TO, ANY IMPLIED WARRANTIES, DUTIES OR CONDITIONS OF MERCHANTABILITY, OF FITNESS FOR A PARTICULAR PURPOSE, OF ACCURACY OR COMPLETENESS OF RESPONSES, OF RESULTS, OF WORKMANLIKE EFFORT, OF LACK OF VIRUSES, AND OF LACK OF NEGLIGENCE, ALL WITH REGARD TO THE SOFTWARE AND THE PROVISION OF OR FAILURE TO PROVIDE SUPPORT SERVICES. ALSO, THERE IS NO WARRANTY OR CONDITION OF TITLE, QUIET ENJOYMENT, QUIET POSSESSION, CORRESPONDENCE TO DESCRIPTION OR NON-INFRINGEMENT WITH REGARD TO THE SOFTWARE.

EXCLUSION OF INCIDENTAL, CONSEQUENTIAL AND CERTAIN OTHER DAMAGES

TO THE MAXIMUM EXTENT PERMITTED BY APPLICABLE LAW, IN NO EVENT SHALL ACER, ACER'S SUPPLIERS, OR ACER'S LICENSORS, BE LIABLE FOR ANY SPECIAL, INCIDENTAL, INDIRECT, PUNITIVE, OR CONSEQUENTIAL DAMAGES WHATSOEVER (INCLUDING, BUT NOT LIMITED TO, DAMAGES FOR LOSS OF PROFITS OR CONFIDENTIAL OR OTHER INFORMATION, FOR BUSINESS INTERRUPTION, FOR PERSONAL INJURY, FOR LOSS OF PRIVACY, FOR FAILURE TO MEET ANY DUTY INCLUDING OF GOOD FAITH OR OF REASONABLE CARE, FOR NEGLIGENCE, AND FOR ANY OTHER PECUNIARY OR OTHER LOSS WHATSOEVER) ARISING OUT OF OR IN ANY WAY RELATED TO THE USE OF OR INABILITY TO USE THE SOFTWARE, THE PROVISION OF OR FAILURE TO PROVIDE SUPPORT SERVICES, OR OTHERWISE UNDER OR IN CONNECTION WITH ANY

PROVISION OF THIS AGREEMENT, EVEN IN THE EVENT OF THE FAULT, TORT (INCLUDING NEGLIGENCE), STRICT LIABILITY, BREACH OF CONTRACT OR BREACH OF WARRANTY OF ACER OR ITS SUPPLIERS OR LICENSORS, AND EVEN IF ACER AND ITS SUPPLIERS AND LICENSORS HAVE BEEN ADVISED OF THE POSSIBILITY OF SUCH DAMAGES.

LIMITATION OF LIABILITY AND REMEDIES

NOTWITHSTANDING ANY DAMAGES THAT YOU MIGHT INCUR FOR ANY REASON WHATSOEVER (INCLUDING, WITHOUT LIMITATION, ALL DAMAGES REFERENCED ABOVE AND ALL DIRECT OR GENERAL DAMAGES), THE ENTIRE LIABILITY OF ACER, ITS SUPPLIERS, AND ITS LICENSORS, UNDER ANY PROVISION OF THIS AGREEMENT, AND YOUR EXCLUSIVE REMEDY FOR ALL OF THE FOREGOING, SHALL BE LIMITED TO THE AGGREGATE AMOUNT PAID BY YOU FOR THE SOFTWARE. THE FOREGOING LIMITATIONS, EXCLUSIONS AND DISCLAIMERS (INCLUDING DISCLAIMER OF WARRANTIES AND EXCLUSION OF INCIDENTAL, CONSEQUENTIAL AND CERTAIN OTHER DAMAGES ABOVE) SHALL APPLY TO THE MAXIMUM EXTENT PERMITTED BY APPLICABLE LAW, EVEN IF ANY REMEDY FAILS ITS ESSENTIAL PURPOSE; PROVIDED, HOWEVER, THAT BECAUSE SOME JURISDICTIONS DO NOT ALLOW THE EXCLUSION OR LIMITATION OR LIABILITY FOR CONSEQUENTIAL OR INCIDENTAL DAMAGES, THE ABOVE LIMITATION MAY NOT APPLY TO YOU.

TERMINATION

Without prejudice to any other rights, Acer may immediately terminate this Agreement without notice if you fail to comply with any terms and conditions of this Agreement.

In such event, you must:

1. Cease all use of the Software;
2. Destroy or return to Acer the original and all copies of the Software; and
3. Delete the Software from all devices on which it was resident.

All disclaimers of warranties and limitation of liability set forth in this Agreement shall survive termination of this Agreement.

GENERAL

This Agreement represents the complete agreement between you and Acer relating to this license for the Software and supersedes all prior agreements, communications, proposals and representations between the parties and prevails over any conflicting or additional terms of any quote, order, acknowledgement or similar communication. This Agreement may only be modified by a written document signed by both parties. If any provision of this Agreement is held by a court of competent jurisdiction to be contrary to law that provision will be enforced to the maximum extent permissible and the remaining provisions of this Agreement will remain in full force and effect.

ADDITIONAL PROVISIONS APPLICABLE TO THIRD PARTY SOFTWARE AND SERVICES

Software provided hereunder by Acer's licensors or suppliers ("Third Party Software") is made available to you for your personal, non-commercial use only. You may not use the Third Party Software in any manner that could damage, disable, overburden, or impair the services provided by Acer's licensors or suppliers hereunder ("Third Party Services"). Furthermore, you may not use the Third Party Software in any manner that could interfere with any other party's use and enjoyment of the Third Party Services, or the services and products of Acer's licensors' or suppliers' third party licensors. Your use of the Third Party Software and Third Party Services is also subject to additional terms and conditions and policies which can be accessed through our global website.

Privacy policy

During registration you will be asked to submit some information to Acer. Please refer to Acer's privacy policy at www.acer.com/worldwide/support/swa.htm or your local Acer website.