

acer

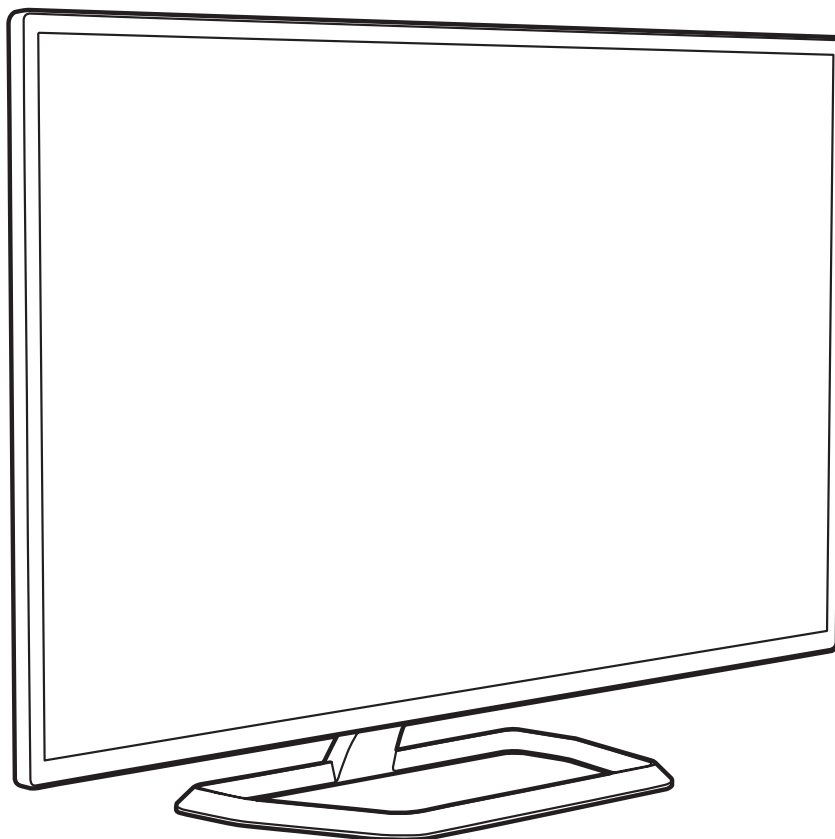

LCD monitor EZ1 series-EZ321Q

USER GUIDE





Acer LCD Monitor Quick Start Guide (QSG)

Important safety instructions

Please read the following instructions carefully.

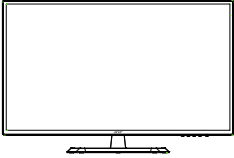
1. To clean the LCD monitor screen:
 - Turn off the LCD monitor and unplug the power cord.
 - Spray a non-solvent cleaning solution onto a rag and clean the screen gently.
2. Do not place the LCD monitor near a window. Exposing the monitor to rain, moisture or sunlight can severely damage it.
3. Do not apply pressure to the LCD screen. Excessive pressure may cause permanent damage to the display.
4. Do not remove the cover or attempt to service this unit yourself. An authorized technician should perform servicing of any nature.
5. Store the LCD monitor in a room with a temperature of -20° to 60° C (-4° to 140° F). Storing the LCD monitor outside this range may result in permanent damage.
6. Immediately unplug your monitor and call an authorized technician if any of the following circumstances occur:
 - Monitor-to-PC signal cable is frayed or damaged.
 - Liquid spills onto the LCD monitor or the monitor is exposed to rain.
 - The LCD monitor or case is damaged.

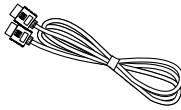
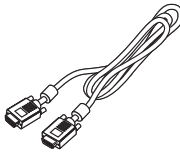
Package contents

LCD monitor	Power cord	HDMI cable (optional)	VGA cable (optional)	Quick start guide
				

Attaching the monitor to the base

1. Place the monitor face down on a flat and clean surface.
2. Align the screw holes on the monitor with the screw holes on the stand.
3. Replace the four screws that secure the monitor to the base. Tighten the screws firmly.





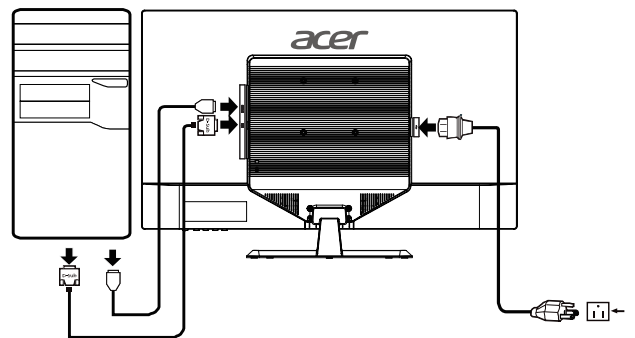

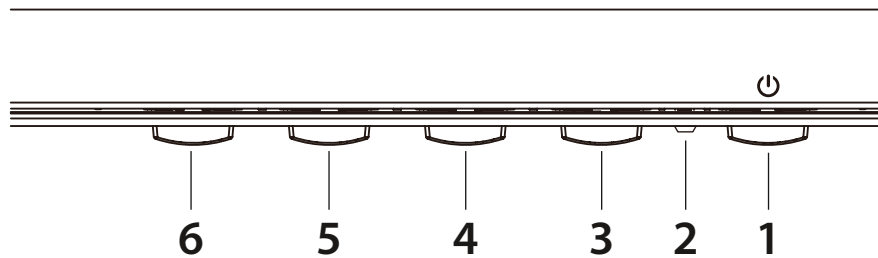
Connecting your monitor to a computer

1. Turn off your computer and unplug your computer's power cord.
2. Connect the signal cable to the VGA and/or HDMI (optional) input socket of the monitor, and the VGA (optional) and/or HDMI (optional) output socket of the graphics card on the computer. Then tighten the thumbscrews on the signal cable connector.
3. Insert the monitor power cable into the power port at the back of the monitor.
4. Plug the power cords of your computer and your monitor into a nearby electrical outlet.





External controls

1 & 2		LED Indicator/ Power button	Turns the monitor on/off. Blue indicates power on. Amber indicates standby/power saving mode.
3		OSD functions/ Down/Right	a. Press to view the OSD. b. Press this button to select the desired item when in OSD menu.
4		Input source switching/Up/Left	a. Use the INPUT hotkey to enter Input select function. b. Press this button to select the desired item when in OSD menu.
5		Brightness key	Press this button to adjust Brightness.
		Enter	a. Press to enter a selection in the OSD. b. When OSD Lock push 3 seconds Lock function is disabled
6		Empowering Key	Press this button to select scenario modes.
		Exit	When the OSD menu is active, this button will act as the exit key (exit OSD menu).

Regulations and safety notices

FCC notices

This device has been tested and found to comply with the limits for a Class B digital device pursuant to Part 15 of the FCC rules. These limits are designed to provide reasonable protection against harmful interference in a residential installation. This device generates, uses, and can radiate radio frequency energy and, if not installed and used in accordance with the instructions, may cause harmful Interference to radio communications. However, there is no guarantee that interference will not occur in a particular installation. If this device does cause harmful interference to radio or television reception, which can be determined by turning the device off and on, the user is encouraged to try to correct the interference by one or more of the following measures:

- Reorient or relocate the receiving antenna.
- Increase the separation between the device and receiver.
- Connect the device into an outlet on a circuit different from that to which the receiver is connected.
- Consult the dealer or an experienced radio/television technician for help.

CE declaration of conformity

Hereby, Acer Inc., declares that this LCD monitor is in compliance with the essential requirements and other relevant provisions of EMC Directive 2014/30/EU, Low Voltage Directive 2014/35/EU, and RoHS Directive 2011/65/EU and Directive 2009/125/EC with regard to establishing a framework for the setting of ecodesign requirements for energy-related product.

Notice: Shielded cables

All connections to other computing devices must be made using shielded cables to maintain compliance with EMC regulations.

Notice: Peripheral devices

Only peripherals (input/output devices, terminals, printers, etc.) certified to comply with the Class B limits may be attached to this equipment. Operation with non-certified peripherals is likely to result in interference to

radio and TV reception.

Caution

Changes or modifications not expressly approved by the manufacturer could void the user authority, which is granted by the Federal Communications Commission, to operate this product.

Operation conditions

This device complies with Part 15 of the FCC Rules. Operation is subject to the following two conditions: (1) this device may not cause harmful interference, and (2) this device must accept any interference received, including interference that may cause undesired operation.

Notice: Canadian users

CAN ICES-3(B)/NMB-3(B)



Disposal of waste equipment by user in private household in the European Union

This symbol on the product or on its packaging indicates that this product must not be disposed of with your other household waste. Instead, it is your responsibility to dispose of your waste equipment by handing it over to a designated collection point for the recycling of waste electrical and electronic equipment. The separate collection and recycling of your waste equipment at the time of disposal will help to conserve natural resources and ensure that it is recycled in a manner that protects human health and the environment. For more information about where you can drop off your waste equipment for recycling, please contact your local city office, your household waste disposal service or the shop where you purchased the product.

*Acer monitor is purposed for video and visual display of information obtained from electronic devices.

SPECIFICATIONS

LCD Panel	Driving system	TFT Color LCD	
	Size	31.5"W(80cm)	
	Pixel pitch	0.36375(H) x 0.36375(V) mm	
	Brightness (cd/m ²)	300 (Typ)	
	Contrast	100,000,000:1 Max (ACM)	
	Viewable angle	CR=10, 178°(H), 178°(V)	
	Response time	4ms (G to G)	
	Panel Type	In-Plane Switching	
	Video	R, G, B Analog Interface	
	H-Frequency	30KHz-83KHz(VGA), 13KHz-83KHz(HDMI)	
	V-Frequency	55Hz-76Hz(VGA), 50Hz-76Hz(HDMI)	
Display Colors		16.7M Colors	
Dot Clock		170 MHz	
Max. Resolution		1920 x 1080@60Hz	
Plug & Play		VESA DDCCI/DDC2B	
Energy Efficiency Class		A+	
*Annual Energy Consumption		40 (kWh) (for HDMI-input Model)	
Power consumption (at 250 nits)	On Mode	22W(typical)	
	Sleep Mode	0.25W(typical)	
	Off Mode	0.24W(typical)	
Input Connector		D-Sub HDMI(Only HDMI Model)	
Input Video Signal		Analog: 0.7Vp-p(standard), 75 OHM, Positive HDMI signal (Only HDMI Model)	
Maximum Screen Size	Horizontal	698.4mm	
	Vertical	392.85mm	
Power Source		100-240V~, 50/60Hz	
Environmental Considerations		Operating Temp: 0° to 40°C Storage Temp: -20° to 60°C Operating Humidity: 20% to 80%	
Dimensions (W x H x D)		725.9 x 479 x 180mm	
Weight (N. W.)		5kg (net)	
Mechanism specifications		Tilt: - 5° to +10° Swivel: No Height adjustment: No	Pivot: No Detachable foot stand: Yes
External Controls	Buttons	Power Button Menu Input	Brightness /Enter E(Empowering) Key /Exit
	Functions	BlueLight Brightness Contrast Color Temp Modes sRGB mode Gamma Super Sharpness 6-axis Hue 6-axis Saturate H.Position V.Position Focus Clock	Auto Config Language OSD Timeout Wide Mode DDC/CI On/Off ACM On/Off Input OD Auto Source Quick Start Mode Reset AllSettings Information
*All specifications are subject to change without notice.			

Regulatory Compliance



E137379
US LISTED
I.T.E.



Find manuals and other documents for your Acer product on the official Acer support website.

*Annual energy consumption is calculated using the typical power consumption 4 hours per day, 365 days per year.