

acer

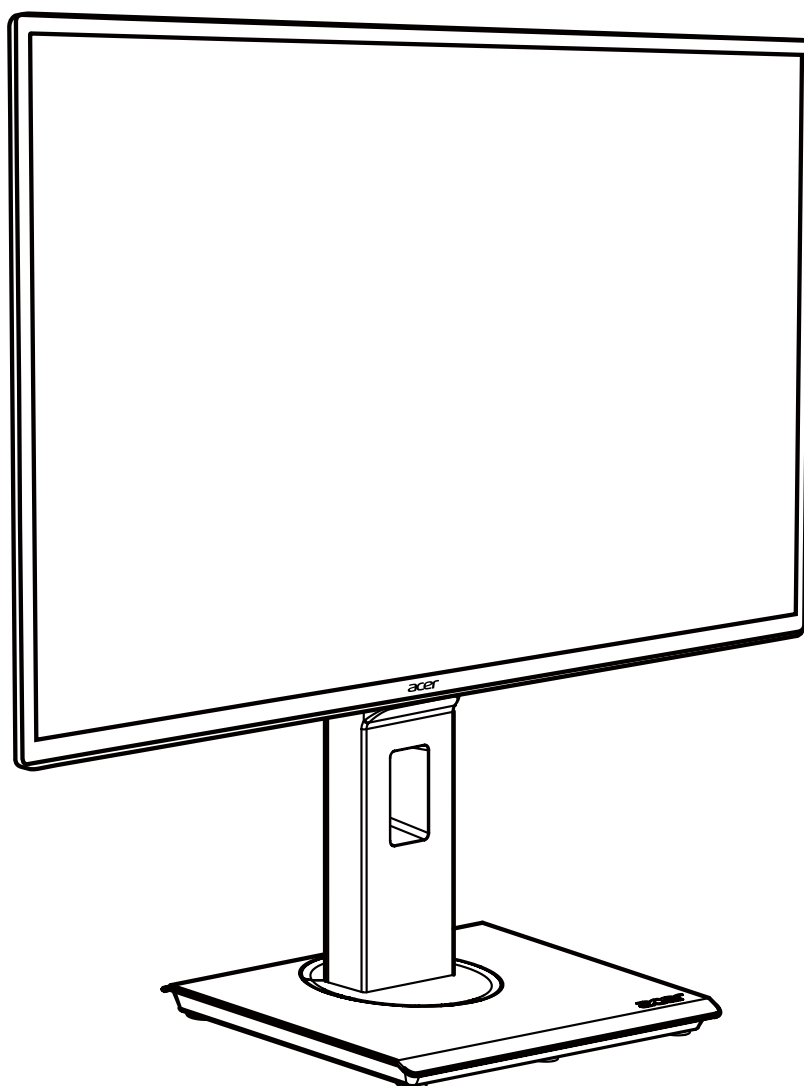

LCD monitor EB5 series-EB275U

USER GUIDE





Acer LCD Monitor Quick Start Guide (QSG)

Important safety instructions

Please read the following instructions carefully.

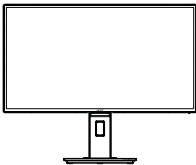
1. To clean the LCD monitor screen:
 - Turn off the LCD monitor and unplug the power cord.
 - Spray a non-solvent cleaning solution onto a rag and clean the screen gently.
2. Do not place the LCD monitor near a window. Exposing the monitor to rain, moisture or sunlight can severely damage it.
3. Do not apply pressure to the LCD screen. Excessive pressure may cause permanent damage to the display.
4. Do not remove the cover or attempt to service this unit yourself. An authorized technician should perform servicing of any nature.
5. Store the LCD monitor in a room with a temperature of -20° to 60°C (-4° to 140°F). Storing the LCD monitor outside this range may result in permanent damage.
6. Immediately unplug your monitor and call an authorized technician if any of the following circumstances occur:
 - Monitor-to-PC signal cable is frayed or damaged.
 - Liquid spills onto the LCD monitor or the monitor is exposed to rain.
 - The LCD monitor or case is damaged.

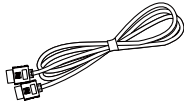
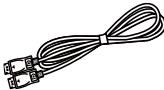
Package contents

LCD monitor	Power cord	HDMI cable (optional)	DP cable (optional)	Quick start guide
				

Attaching the monitor to the stand

1. Remove the monitor from the packaging.
2. Attach the footstand to the base.
3. Turn clockwise to lock. Ensure that the base is locked onto the stand.
4. Secure the base to the stand by turning the screw using the integrated tab or a suitable coin.





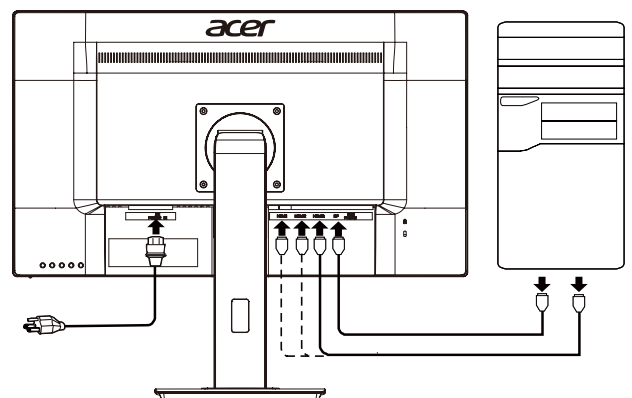

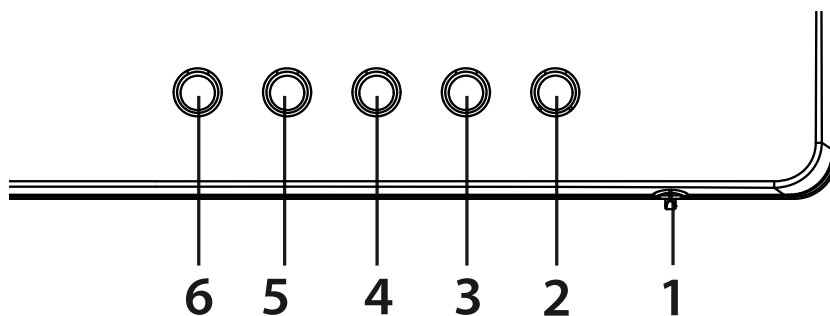
Connecting your monitor to a computer

1. Turn off your computer and unplug your computer's power cord.
2. Connect the signal cable to the DP (optional) and/or HDMI (optional) input socket of the monitor, and the DP (optional) and/or HDMI (optional) output socket of the graphics card on the computer. Then tighten the thumbscrews on the signal cable connector.
3. Insert the monitor power cable into the power port at the back of the monitor.
4. Plug the power cords of your computer and your monitor into a nearby electrical outlet.





External controls

1 & 2		LED Indicator/ Power button	Turns the monitor on/off. Blue indicates power on. Amber indicates standby/power saving mode.
3		OSD functions/ Down/Right	a. Press to view the OSD. b. Press this button to select the desired item when in OSD menu.
4		Input source switching/Up/Left	a. Use the INPUT hotkey to enter Input select function. b. Press this button to select the desired item when in OSD menu.
5		Volume Key	Press this button to adjust volume.
		Enter	Press to enter a selection in the OSD.
6		Empowering Key	Press this button to select scenario mode.
		Exit	When the OSD menu is active, this button will act as the exit key (exit OSD menu).

Regulations and safety notices

FCC notices

This device has been tested and found to comply with the limits for a Class B digital device pursuant to Part 15 of the FCC rules. These limits are designed to provide reasonable protection against harmful interference in a residential installation. This device generates, uses, and can radiate radio frequency energy and, if not installed and used in accordance with the instructions, may cause harmful Interference to radio communications. However, there is no guarantee that interference will not occur in a particular installation. If this device does cause harmful interference to radio or television reception, which can be determined by turning the device off and on, the user is encouraged to try to correct the interference by one or more of the following measures:

- Reorient or relocate the receiving antenna.
- Increase the separation between the device and receiver.
- Connect the device into an outlet on a circuit different from that to which the receiver is connected.
- Consult the dealer or an experienced radio/television technician for help.

CE declaration of conformity

Hereby, Acer Inc., declares that this LCD monitor is in compliance with the essential requirements and other relevant provisions of EMC Directive 2014/30/EU, Low Voltage Directive 2014/35/EU, and RoHS Directive 2011/65/EU and Directive 2009/125/EC with regard to establishing a framework for the setting of ecodesign requirements for energy-related product.

Notice: Shielded cables

All connections to other computing devices must be made using shielded cables to maintain compliance with EMC regulations.

Notice: Peripheral devices

Only peripherals (input/output devices, terminals, printers, etc.) certified to comply with the Class B limits may

be attached to this equipment. Operation with non-certified peripherals is likely to result in interference to radio and TV reception.

Caution

Changes or modifications not expressly approved by the manufacturer could void the user authority, which is granted by the Federal Communications Commission, to operate this product.

Operation conditions

This device complies with Part 15 of the FCC Rules. Operation is subject to the following two conditions: (1) this device may not cause harmful interference, and (2) this device must accept any interference received, including interference that may cause undesired operation.

Notice: Canadian users

CAN ICES-3(B)/NMB-3(B)



Disposal of waste equipment by user in private household in the European Union

This symbol on the product or on its packaging indicates that this product must not be disposed of with your other household waste. Instead, it is your responsibility to dispose of your waste equipment by handing it over to a designated collection point for the recycling of waste electrical and electronic equipment. The separate collection and recycling of your waste equipment at the time of disposal will help to conserve natural resources and ensure that it is recycled in a manner that protects human health and the environment. For more information about where you can drop off your waste equipment for recycling, please contact your local city office, your household waste disposal service or the shop where you purchased the product.

*Acer monitor is purposed for video and visual display of information obtained from electronic devices.

SPECIFICATIONS

English

LCD Panel	Driving system	TFT Color LCD	
	Size	27"W(69cm)	
	Pixel pitch	0.233(H) x 0.233(V) mm	
	Brightness (cd/m ²)	250 (Typ)	
	Contrast	100,000,000:1 Max (ACM)	
	Viewable angle	CR=10, 178°(H), 178°(V)	
	Response time	5ms (G to G)	
	Panel Type	In-Plane Switching	
	Video	R, G, B Analog Interface	
H-Frequency		31KHz-90KHz	
V-Frequency		48Hz-75Hz	
Display Colors		16.7M Colors	
Dot Clock		82.5 MHz	
Max. Resolution		2560 x 1440@75Hz	
Plug & Play		VESA DDCCI/DDC2B	
Energy Efficiency Class		A	
*Annual Energy Consumption		41 (kWh) (for HDMI-input Model)	
Power consumption (at 200 nits)	On Mode	47W (typical)	
	Sleep Mode	0.29W (typical)	
	Off Mode	0.24W (typical)	
Input Connector		DP/HDMI	
Input Video Signal		DP signal/HDMI signal	
Speakers		2Wx2	
Maximum Screen Size	Horizontal	596.736 mm	
	Vertical	335.664mm	
Power Source		100-240V~, 50/60Hz	
Environmental Considerations		Operating Temp: 0° to 40°C Storage Temp: -20° to 60°C Operating Humidity: 20% to 80%	
Dimensions (W x H x D)		620.1x531~411x 207.5mm	
Weight (N. W.)		6.7kg (net)	
Mechanism specifications		Tilt: - 5° to +25° Swivel: Yes Height adjustment: Yes	Pivot: Yes Detachable foot stand: Yes
External Controls	Buttons	Power Button Menu Input	Volume/Enter E(Empowering) Key/Exit
	Functions	BlueLight Brightness Contrast Colour Temp Modes sRGB mode Gamma Super Sharpness 6-axis Hue 6-axis Saturate	Language OSD Timeout Wide Mode DDC/CI On/Off ACM On/Off Input OD FreeSync Auto Source Quick Start Mode Reset Information
*All specifications are subject to change without notice.			

Regulatory Compliance



Find manuals and other documents for your Acer product on the official Acer support website.

*Annual energy consumption is calculated using the typical power consumption 4 hours per day, 365 days per year.