







Acer LCD Monitor Quick Start Guide (QSG)

Important safety instructions

Please read the following instructions carefully.

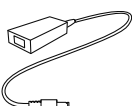
- To clean the LCD monitor screen: Be sure that your monitor is electrically rated to operate with the AC power available in your location.
 - Turn off the LCD monitor and unplug the power cord.
 - Spray a non-solvent cleaning solution onto a rag and clean the screen gently.
 - NEVER SPRAY OR POUR ANY LIQUID DIRECTLY ONTO THE SCREEN OR CASE.**
 - PLEASE DO NOT USE ANY AMMONIA OR ALCOHOL-BASED CLEANERS ON THE LCD DISPLAY SCREEN OR CASE.**
 - Acer will not be liable for damage resulting from use of any ammonia or alcohol-based cleaners.
- Do not place the LCD monitor near a window. Exposing the monitor to rain, moisture or sunlight can severely damage it.
- Do not apply pressure to the LCD screen. Excessive pressure may cause permanent damage to the display.
- Do not remove the cover or attempt to service this unit yourself. An authorized technician should perform servicing of any nature.
- Store the LCD monitor in a room with a temperature of -20° to 60°C (-4° to 140°F). Storing the LCD monitor outside this range may result in permanent damage.
- Immediately unplug your monitor and call an authorized technician if any of the following circumstances occur:
 - Monitor-to-PC signal cable is frayed or damaged.
 - Liquid spills onto the LCD monitor or the monitor is exposed to rain.
 - The LCD monitor or case is damaged.

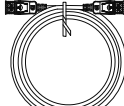
Package contents

LCD monitor	Power cord	Adapter	DVI cable (Optional)	HDMI cable (Optional)	DP cable (Optional)	Quick start guide
						

Attaching the monitor to the base

- Remove the monitor base from the packaging and place it on a stable and level workspace.
- Take out the support, align the rear cover of the display, insert the back cover to ensure that the display and the support connection is stable, do not shake.
- The base is aligned with the support and inserted in the support, the rotating hand twist screw, until the tightening, fixed base.

Connecting Your Monitor to a Computer

- Turn off your monitor and unplug your computer's power cord.
- 2-1 DVI Cable (Optional, only Dual-Input Model)
 - Make sure both the monitor and computer are powered-OFF.
 - Connect the DVI cable to the computer.
- 2-2 Connect DP Cable (Optional, Only DP-input model)
 - Make sure both the monitor and computer are powered-OFF.
 - Connect the DP cable to the computer.
- 2-3 Connect HDMI Cable (Option, Only HDMI-input model)
 - Make sure both the monitor and computer are powered-OFF.
 - Connect the HDMI cable to the computer.
- Connect the Audio Cable. (Option, Only Audio-Input Model)
- Insert the monitor power cable into the power port at the back of the monitor.
- Plug the power cords of your computer and your monitor into a nearby electrical outlet.

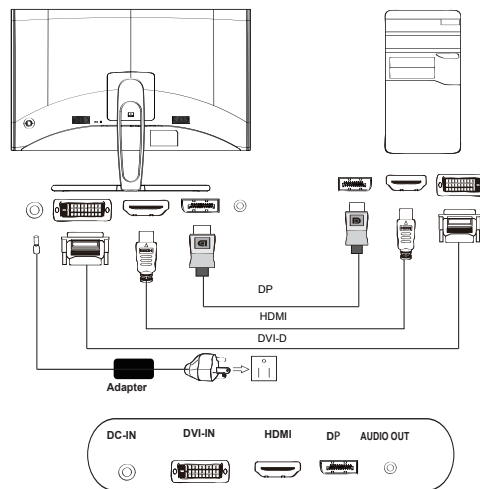

External Controls

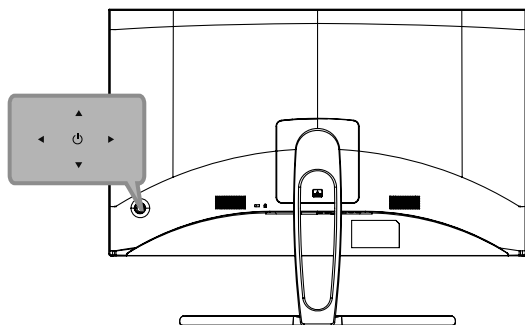

Function key



- Monitor power off status Press to switch power on. In the normal display, anytime to Press more than 5 seconds switch to turn off the power.
- Blue indicates power on. Blue flicker indicates standby/power saving mode. No light display indicates Power off.
- Press to any directions switch key to display First Menu. Press again to enter next function in the First Menu.
- The single toggle button on the backside of the Display bezel operates like a joystick. To move the cursor, simply toggle the button in four directions. Press the button to select desired option. In Main Menu The Green indicates operable, Grey indicates inoperable.

FreeSync (HDMI /DP Only):

It can allow a FreeSync supported graphics source to dynamically adjust display refresh rate based on typical content frame rates for power efficient, virtually stutter free and low-latency display update.

Regulations and safety notices

FCC notice

This device has been tested and found to comply with the limits for a Class B digital device pursuant to Part 15 of the FCC rules. These limits are designed to provide reasonable protection against harmful interference in a residential installation. This device generates, uses, and can radiate radio frequency energy and, if not installed and used in accordance with the instructions, may cause harmful interference to radio communications.

However, there is no guarantee that interference will not occur in a particular installation. If this device does cause harmful interference to radio or television reception, which can be determined by turning the device off and on, the user is encouraged to try to correct the interference by one or more of the following measures:

- Reorient or relocate the receiving antenna.
- Increase the separation between the device and receiver.
- Connect the device into an outlet on a circuit different from that to which the receiver is connected.
- Consult the dealer or an experienced radio/television technician for help.

CE declaration of Conformity

Hereby, Acer Inc., declares that this LCD monitor is in compliance with the essential requirements and other relevant provisions of EMC Directive 2014/30/EU, Low Voltage Directive 2014/35/EU, and RoHS Directive 2011/65/EU and Directive 2009/125/EC with regard to establishing a framework for the setting of ecodesign requirements for energy-related product.

Notice: Shielded cables

All connections to other computing devices must be made using shielded cables to maintain compliance with EMC regulations.

Notice: Peripheral devices

Only peripherals (input/output devices, terminals, printers, etc.) certified to comply with the Class B limits may be attached to this equipment. Operation with non-certified peripherals is likely to result in interference to radio and TV reception.

Caution

Changes or modifications not expressly approved by the manufacturer could void the user authority, which is granted by the Federal Communications Commission, to operate this product.

Operation conditions

This device complies with Part 15 of the FCC Rules. Operation is subject to the following two conditions: (1) this device may not cause harmful interference, and (2) this device must accept any interference received, including interference that may cause undesired operation.

Notice: Canadian users

This Class B digital apparatus complies with Canadian ICES-003.

Remarque à l'intention des utilisateurs canadiens

Cet appareil numérique de la classe B est conforme à la norme NMB-003 du Canada.

Disposal of Waste Equipment by Users in Private Household in the European Union



This symbol on the product or on its packaging indicates that this product must not be disposed of with your other household waste. Instead, it is your responsibility to dispose of your waste equipment by handing it over to a designated collection point for the recycling of waste electrical and electronic equipment. The separate collection and recycling of your waste equipment at the time of disposal will help to conserve natural resources and ensure that it is recycled in a manner that protects human health and the environment. For more information about where you can drop off your waste equipment for recycling, please contact your local city office, your household waste disposal service or the shop where you purchased the product.

In order to prevent damage to the monitor, do not lift the monitor by its base.

Acer monitor is purposed for video and visual display of information obtained from electronic devices.