

Acer Chromebook 311/ C733/ C733T/
C733TU/ C733U

LIFECYCLE EXTENSION GUIDE

Self-Repair 1-1
Disassembly Procedures 1-2
Troubleshooting 1-26
FRU (Field Replaceable Unit) List 1-30
Exploded Diagrams 1-31
Check for updates yourself. 1-34
Factory reset your Chromebook. 1-35

Self-Repair

This chapter highlights the limited self-repair capabilities of the product.

Prior performing self-repair, familiarize yourself with the Safety Guidelines and Recommended Equipment sections first as described in the chapter "[Disassembly Procedures](#)".

Depending on model, the following key components are eligible for self-repair (if applicable);

- Battery pack
- HDD / SSD module
- DIMM module(s)
- WLAN module
- LTE module

If a particular key component is listed and thus would be eligible for self-repair, but is not described in the "[Disassembly Procedures](#)" section, then this component is either not present on the respective model, or it is present but embedded on the motherboard and therefore not eligible for self-repair.

⇒ **NOTE:**

Do not attempt to replace other components than those listed above.

⇒ **NOTE:**

For replacement parts, always use only Acer certified components in order to safeguard quality, optimum system performance, stability and reliability of the product.

⇒ **NOTE:**

Any damage to the product that occur during self-repair, or which has occurred as a result of a careless or unsuccessful self-repair attempt, is not covered by the standard product warranty.

Software Recovery

This product has embedded software recovery tools which can be used to either perform a partial or full software recovery, but also to create a Factory Default recovery media.

For more information about the software recovery options, how to perform a software recovery or creating a Factory Default recovery media, please refer to the chapter "Recovery" which is available in the User Manual of the product.

⇒ **NOTE:**

In the event of not being able to create a Factory Default recovery media, it is possible to obtain a copy of the recovery media through Acer Customer Service (<http://www.acer.com/support>)

This is not a free of charge service.

Disassembly Procedures

Safety Guidelines

This chapter contains step by step procedures on how to remove and de-install components from the computer. Use the following safety guidelines to ensure your personal safety. Each procedure included in this chapter assumes that you are preparing your computer for recycling and disposal. **By performing any of these procedures you acknowledge that any remaining warranty applicable to your computer will be voided. Before you start any of the procedures in this chapter, make sure to read the following safety guidelines and the respective instructions within the chapter.**

CAUTION!

- Turn off your computer and disconnect all power sources before opening the computer cover or panels.
- To avoid electrostatic discharge, ground yourself by using a wrist grounding strap or by periodically touching an unpainted metal surface at the same time as touching a connector on the back of the computer.
- Take off any metal objects on your arms or fingers such as bracelets, rings or watches and make sure your hands are completely dry. Even if your unit is unplugged, there may still be some remaining electric charge.
- If a component does not come out easily, do not forcefully remove it. Instead, check that you are removing it correctly and that no wires or other parts are in the way.
- When you disconnect a cable, pull on its connector or on its pull-tab, not on the cable itself. Some cables have connectors with locking tabs; if you are disconnecting this type of cable, press in on the locking tabs before you disconnect the cable.

Recommended Equipment

The following equipment are recommended to do the following maintenance procedures:

- Wrist grounding strap and conductive mat
- Flat screwdriver
- Philips screwdriver #0 and #1
- Plastic tweezers
- Flat plastic pry

WEEE Annex VII Component

These components are classified as requiring selective treatment:

- Battery pack
- WLAN module
- Touchpad module
- USB board
- Mainboard
- LCD panel

Pre-disassembly Instructions

Do the following prior to starting any maintenance procedures:

1. Place the system on a stable work surface.
2. Remove the power adapter from the USB Type-C port (A) as shown in [Figure 1-1](#) or from the USB Type-C port (C) as shown in [Figure 1-2](#).
3. Remove the microSD card from the microSD card slot (B) ([Figure 1-1](#)).
4. Remove all cables from system.

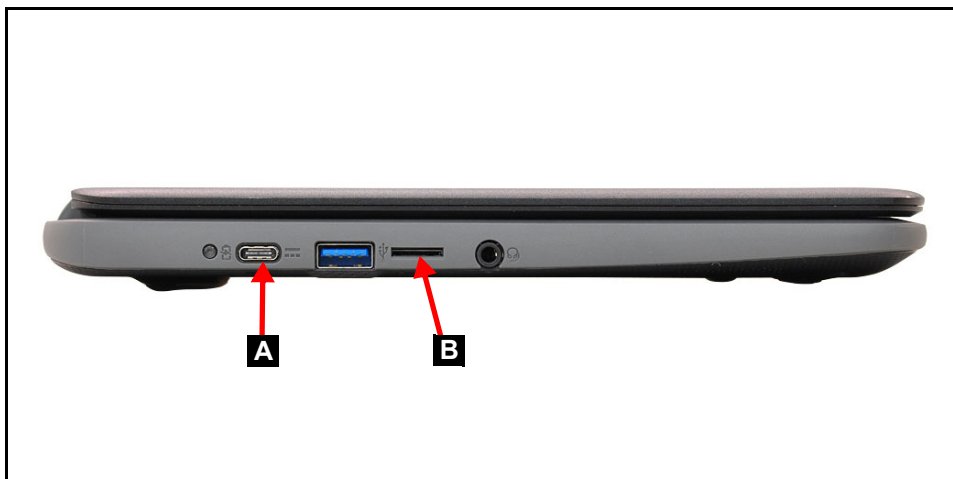

Figure 1-1. AC Adapter Outlet & microSD Card Slot



Figure 1-2. AC Adapter Outlet

⇒ **NOTE:**

Make sure the system is completely powered off.

Base Cover Removal

1. Remove twelve (12) screws from the base cover (Figure 1-3).



Figure 1-3. Base Cover Removal

2. Using a scribe, carefully pry open the base cover starting from the gap between the base cover and top assembly next to the LCD hinge (as indicated in yellow) (Figure 1-4).
3. Slide the scribe along the edges of the base cover in the direction indicated until all the latches have been released (Figure 1-4).



Figure 1-4. Base Cover Removal

4. Lift the base cover from the left side of the system and remove the base cover from the system in the direction indicated (Figure 1-5).



Figure 1-5. Base Cover Removal

Battery Pack Removal

Prerequisite:

Base Cover Removal

1. Locate the battery (A) on the top assembly (Figure 1-6).
2. Peel off the piece of tape from the keyboard FPC and battery connector (Figure 1-6).

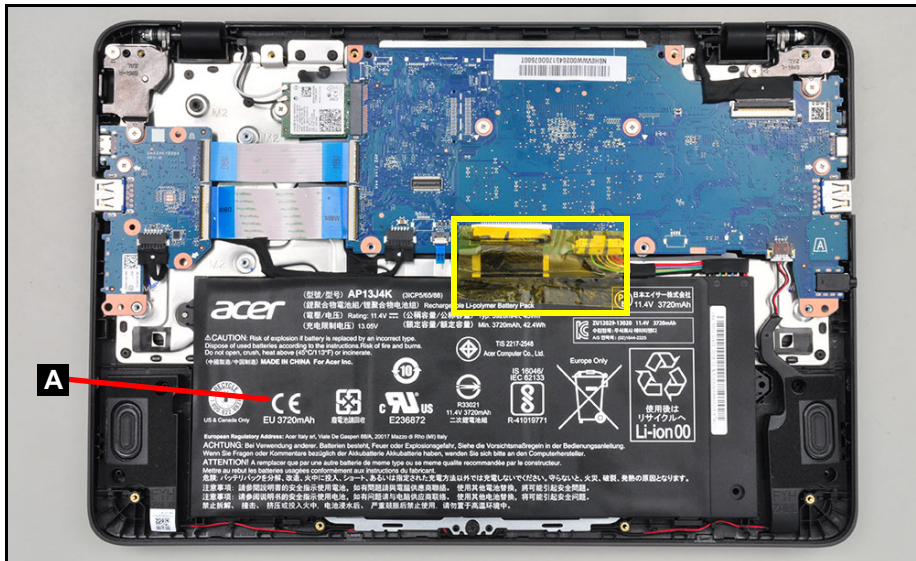

Figure 1-6. Battery Pack Removal

3. Disconnect the battery cable (B) from the mainboard connector (C) (Figure 1-7).

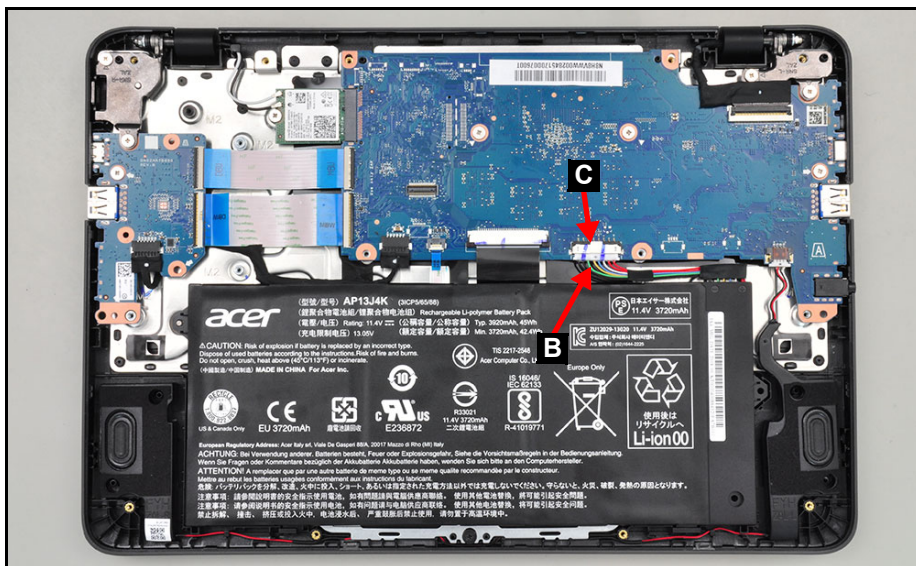

Figure 1-7. Battery Pack Removal

4. Remove the battery pack from the system (Figure 1-8).



Figure 1-8. Battery Pack Removal

+ **IMPORTANT:**

Follow local regulations for battery disposal.

WLAN (Wireless Local Area Network) Module Removal

Prerequisite:

Battery Pack Removal

1. Locate the WLAN module (A) on the top assembly (Figure 1-9).

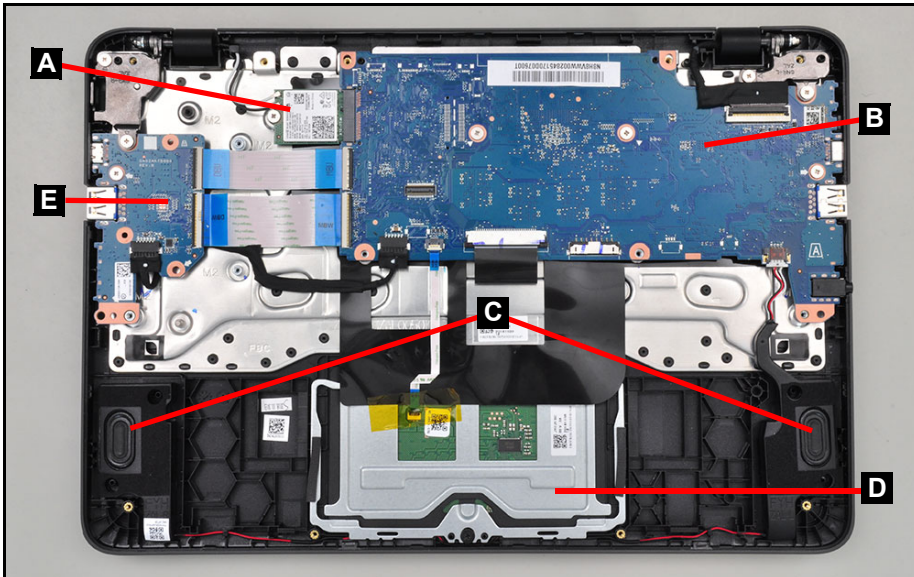

Figure 1-9. Component Location

2. Disconnect WLAN antennas cables (B) from the WLAN module connectors (Figure 1-10).
3. Remove one (1) screw (C) securing the WLAN module in place (Figure 1-10).

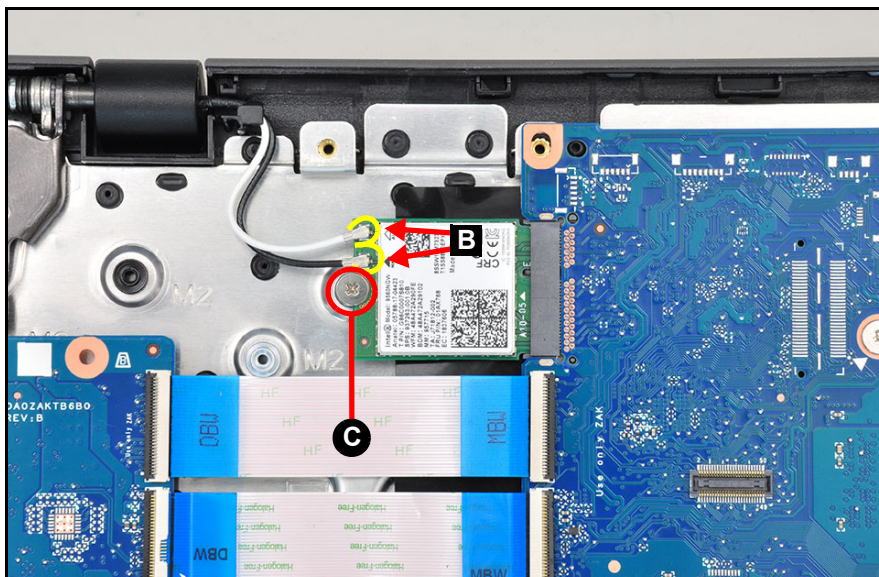

Figure 1-10. WLAN Module Removal

4. Remove the WLAN module (A) from the mainboard connector (D) (Figure 1-11).

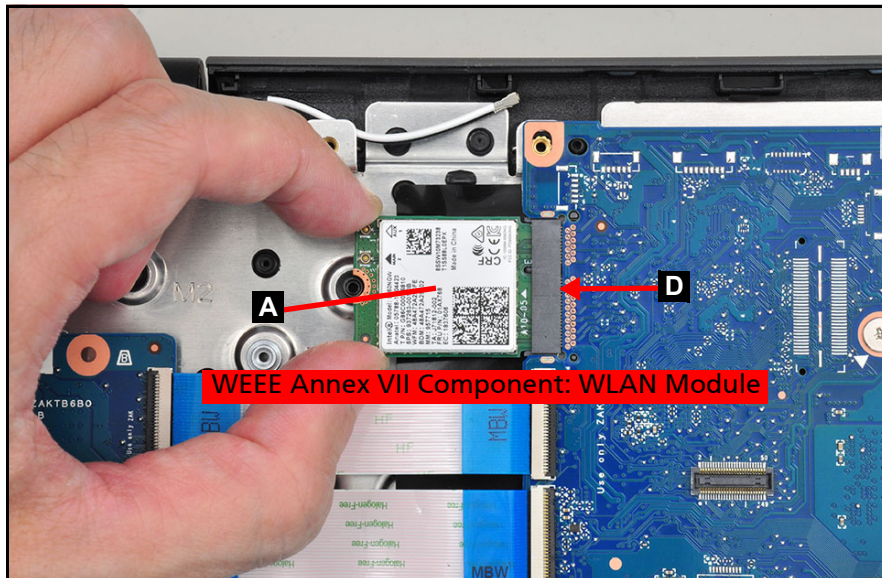

Figure 1-11. WLAN Module Removal

LCD Module Removal

Prerequisite:

Battery Pack Removal

1. Disconnect the WLAN antennas cables (A) from the WLAN module connectors (Figure 1-12).
2. Disconnect the eDP cable (C) from the mainboard connector (D) (Figure 1-12).
3. Unroute all cables from the cable guides (as indicated by the green rectangles) (Figure 1-12).

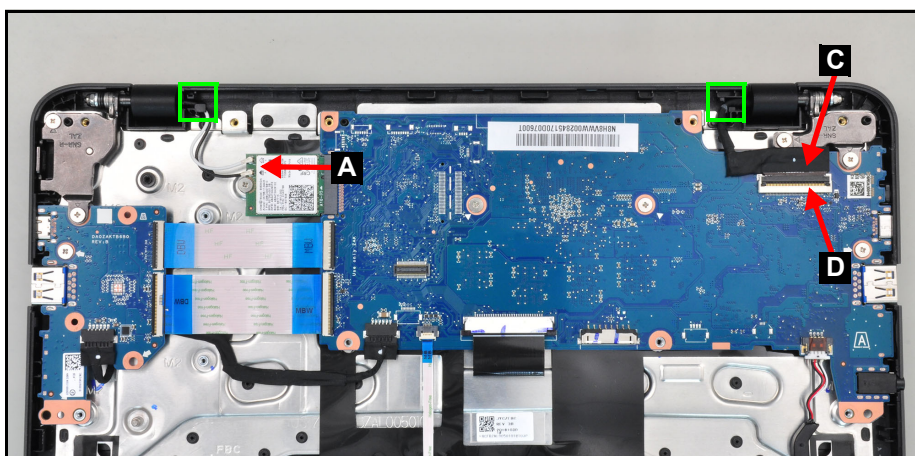

Figure 1-12. LCD Module Removal

4. Open the LCD module (G) to a 90-degree angle and place the system on a flat surface as shown in Figure 1-13.
5. Remove four (4) screws (F) securing the LCD module in place (Figure 1-13).

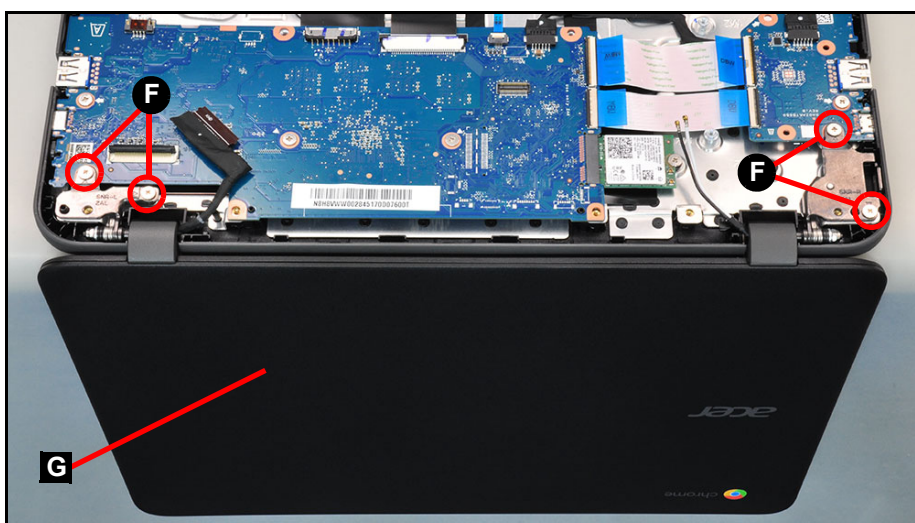

Figure 1-13. LCD Module Removal

6. Lift to remove the LCD module from the top assembly (Figure 1-14).

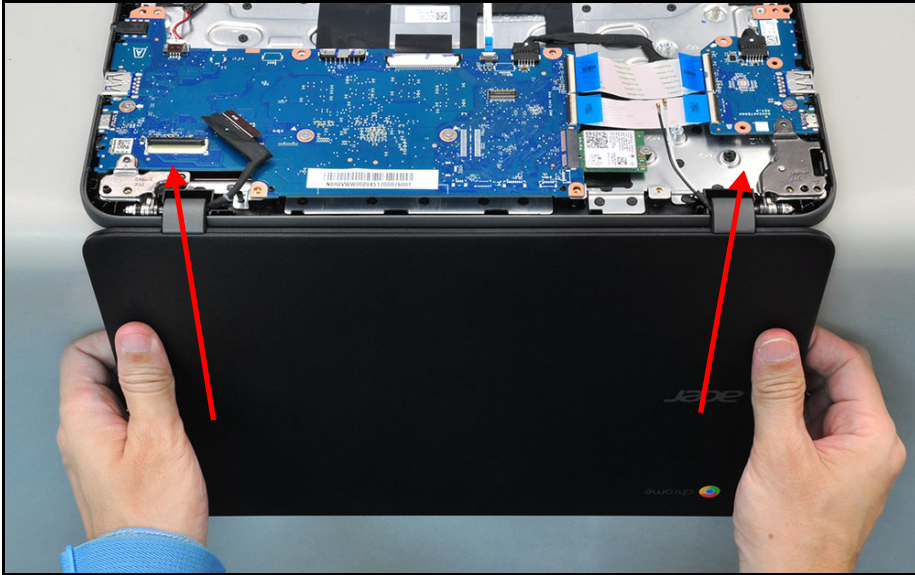

Figure 1-14. LCD Module Removal

⚠ CAUTION:

Make sure all cables and antennas are unthreaded from the cable guides to avoid damage during the removal process.

Touchpad Module Removal

Prerequisite:

Battery Pack Removal

1. Locate the touchpad module (D) on the top assembly. Refer to [Figure 1-9](#).
2. Peel off the piece of tape from the touchpad connector ([Figure 1-15](#)).

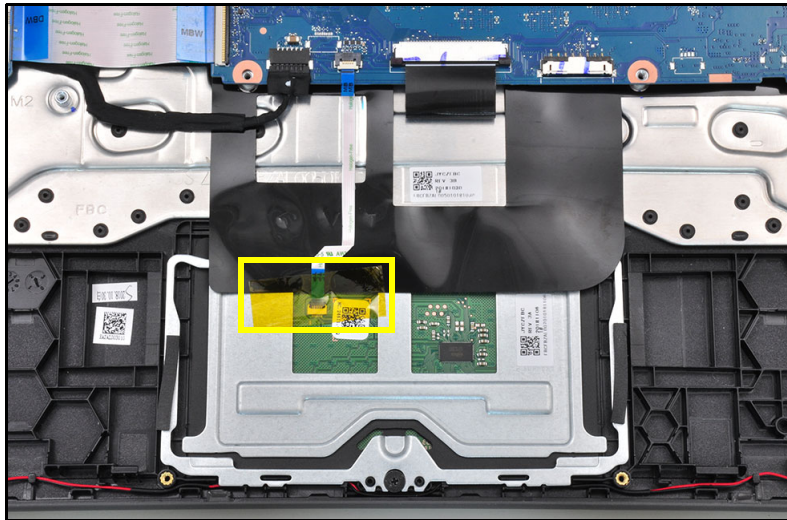

Figure 1-15. Touchpad Tape Removal

3. Disconnect the touchpad FFC (E) from the mainboard connector (B) and touchpad module connector (C) and then peel off the touchpad FFC ([Figure 1-16](#)).
4. Peel back the keyboard plate mylar (as indicated in yellow) ([Figure 1-16](#)).

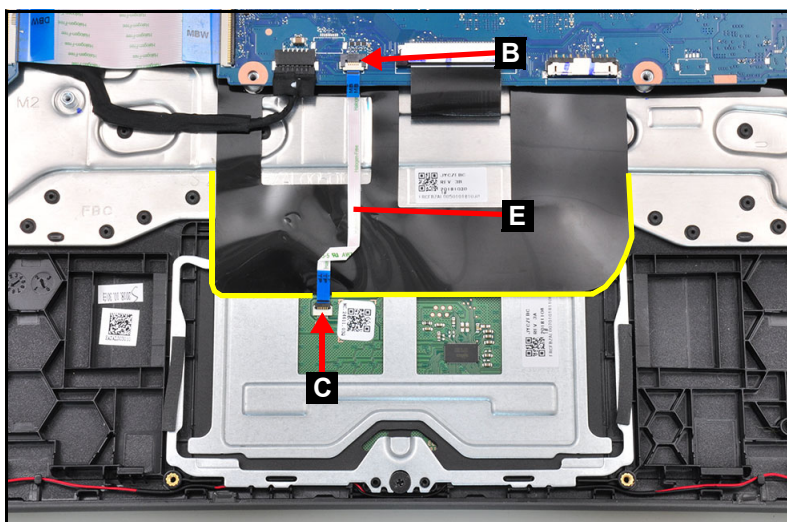

Figure 1-16. Touchpad FFC Removal

5. Remove four (4) screws (G) securing the touchpad module in place (Figure 1-17).

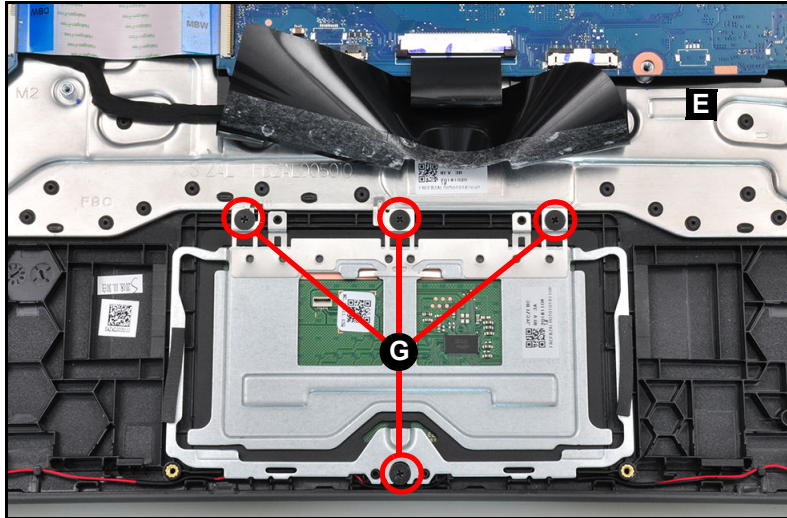

Figure 1-17. Touchpad Module Screw Location

6. Remove the touchpad module (D) from the top assembly (Figure 1-18).

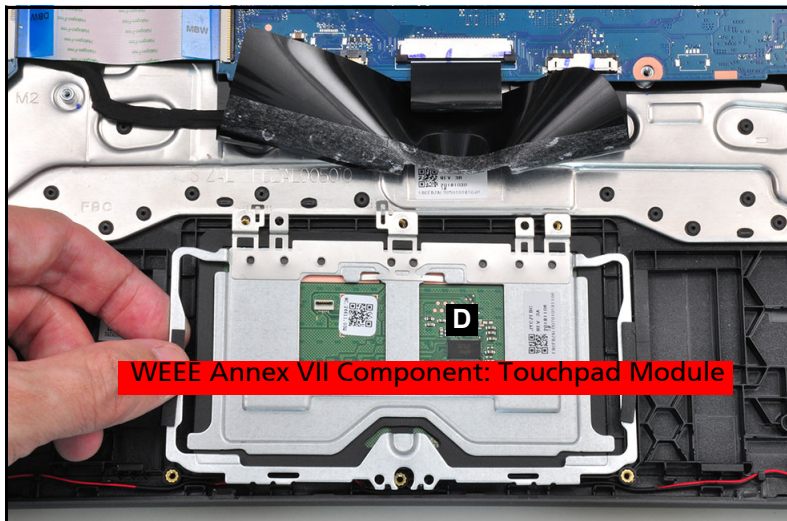

Figure 1-18. Touchpad Module Removal

⚠ CAUTION:

Touchpad FFC (Flexible Flat Cable) can be damaged if removed while the mainboard connector and touchpad connector are locked.

USB Board Removal

Prerequisite:

LCD Module Removal

1. Locate the USB board (E) on the top assembly. Refer to [Figure 1-9](#).
2. [For C733T & C733 only] Disconnect the 30-pin USB board FFC (D) from the mainboard connector (A) and USB board connector (C) and remove the 30-pin USB board FFC ([Figure 1-19](#)).
3. Disconnect the 40-pin USB board FFC (G) from the mainboard connector (H) and USB board connector (F) and remove the 40-pin USB board FFC ([Figure 1-19](#)).
4. [For C733T & C733 only] Disconnect the USB board power cable (K) from the mainboard connector (J) and USB board connector (L) ([Figure 1-19](#)).
5. Remove one (1) screw (B) securing the USB board in place ([Figure 1-19](#)).

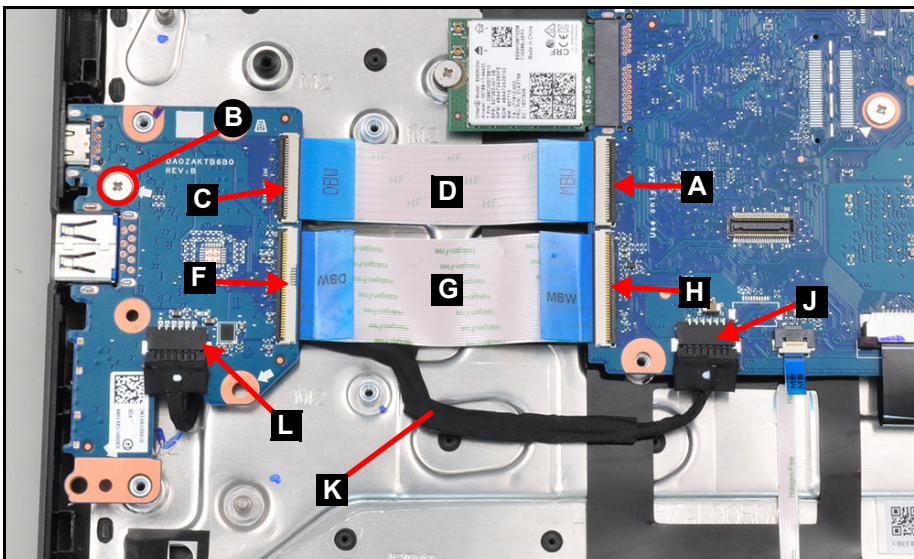

Figure 1-19. USB Board Removal

6. Remove the USB board (E) from the top assembly (Figure 1-20).



Figure 1-20. USB Board Removal

7. [For C733T & C733 only] Peel off the USB board power cable (K) from the top assembly (Figure 1-21).

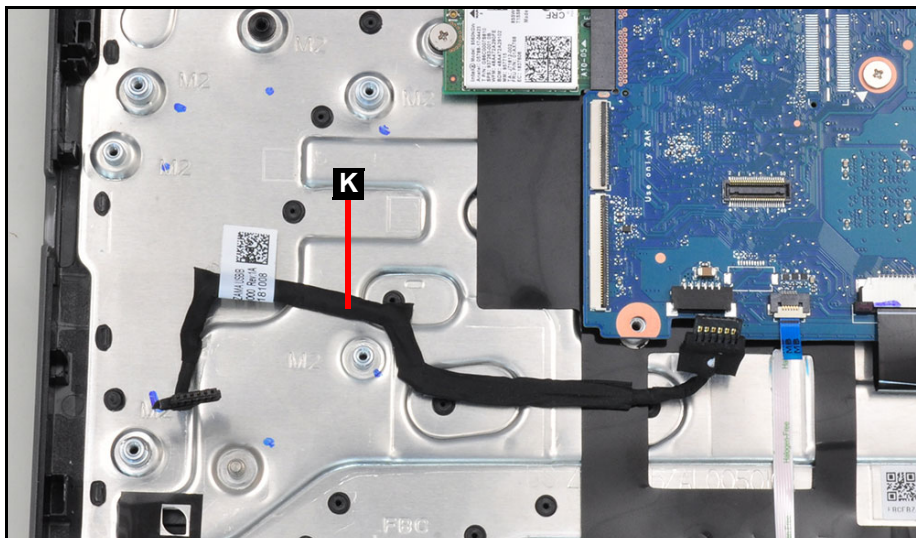

Figure 1-21. USB Board Removal

8. Flip over the USB board and remove the adhesive rubber (M) from the USB board (Figure 1-22).

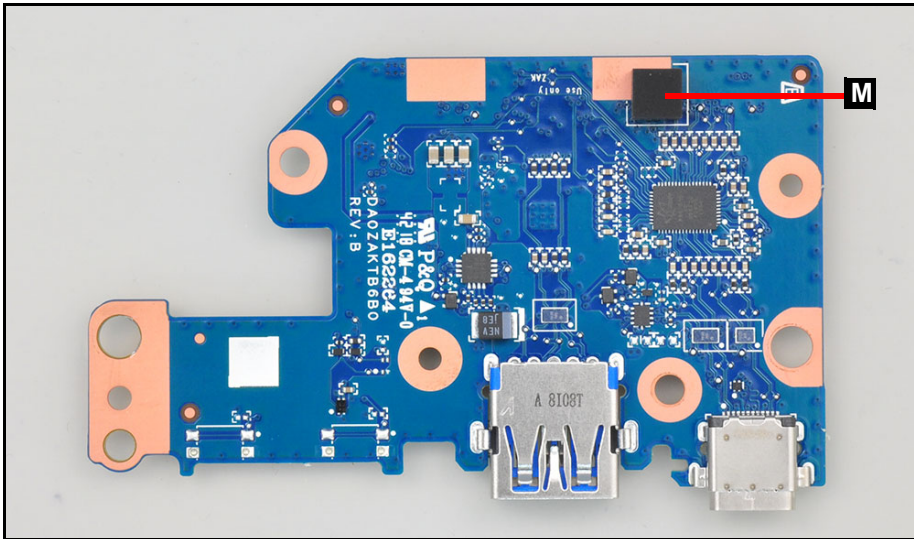

Figure 1-22. Adhesive Rubber Removal

⇒ NOTE:

The adhesive rubber is a separate service part and must be removed and re-installed when replacing the USB board.

⚠ CAUTION:

The 30-pin and 40-pin USB board FFC (Flexible Flat Cable) can be damaged if removed while the mainboard connector and USB board connector are locked.

Mainboard Removal

Prerequisite:

[WLAN \(Wireless Local Area Network\) Module Removal](#) and [LCD Module Removal](#)

1. Locate the mainboard (B) on the top assembly. Refer to [Figure 1-9](#).
2. [For C733T & C733 only] Disconnect the 30-pin USB board FFC from the mainboard connector (C) ([Figure 1-23](#)).
3. Disconnect the 40-pin USB board FFC from the mainboard connector (D) ([Figure 1-23](#)).
4. [For C733T & C733 only] Disconnect the USB board power cable from the mainboard connector (E) ([Figure 1-23](#)).
5. Disconnect the touchpad FFC from the mainboard connector (F) ([Figure 1-23](#)).
6. Disconnect the keyboard FPC from the mainboard connector (G) ([Figure 1-23](#)).
7. Disconnect the speaker cable from the mainboard connector (H) ([Figure 1-23](#)).
8. Remove three (3) screws (A) securing the mainboard in place ([Figure 1-23](#)).

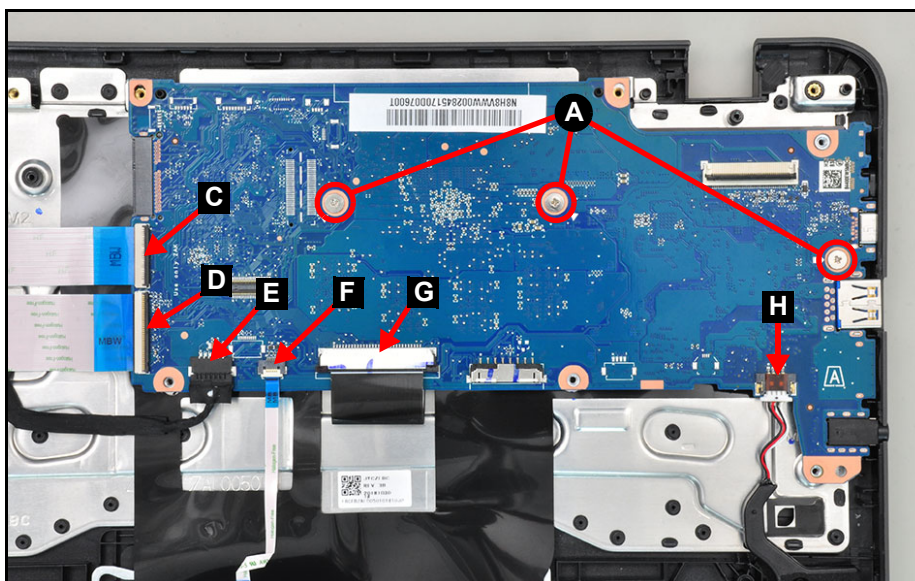

Figure 1-23. Mainboard Connector & Screw Location

⚠ CAUTION:

Make sure all FFCs, FPCs and cables are disconnected from the mainboard connectors to avoid damage during the removal process.

9. Gently lift the mainboard from the left side and remove it from the top assembly (Figure 1-24).



Figure 1-24. Mainboard Removal

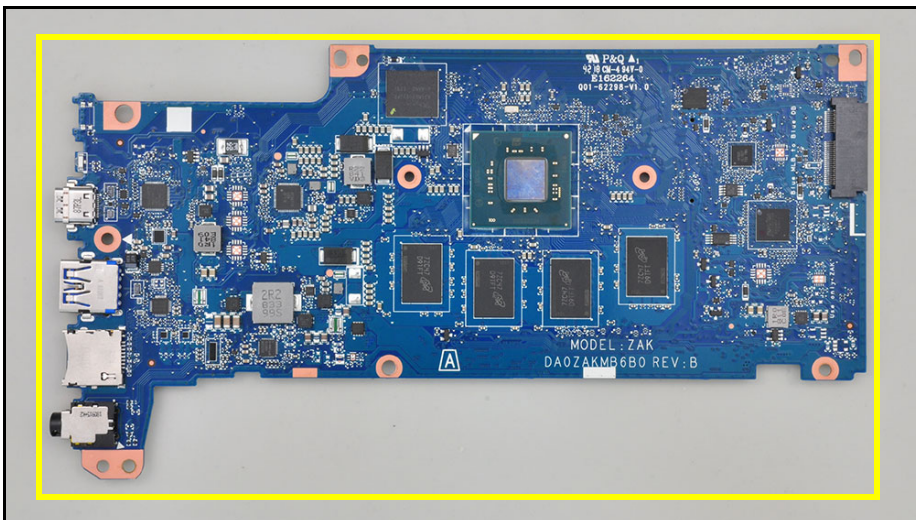

Figure 1-25. Mainboard

+ **IMPORTANT:**

Circuit boards >10 cm² have been highlighted with a yellow rectangle as shown in Figure 1-25. Remove the circuit board and follow local regulations for disposal.

LCD Bezel Removal

Prerequisite:

[LCD Module Removal](#)

1. Using a flat headed tool, pry open from the top left corner of the LCD module and then slide the tool through the top side of the LCD module to release the LCD bezel from the latches ([Figure 1-26](#)).



Figure 1-26. LCD Bezel Removal

2. Continue along the right side of the LCD module ([Figure 1-27](#)).



Figure 1-27. LCD Bezel Removal

3. Continue along the left side of the LCD module (Figure 1-28).



Figure 1-28. LCD Bezel Removal

4. Continue along the bottom side of the LCD module and pry to release the LCD bezel from the latches close to the hinge caps (Figure 1-29).



Figure 1-29. LCD Bezel Removal

5. Lift to remove the LCD bezel from the LCD module ([Figure 1-30](#)).



Figure 1-30. LCD Bezel Removal

LCD Panel Removal

Prerequisite:

LCD Bezel Removal

1. Locate the LCD panel (C) on the LCD cover. Refer to [Figure 1-31](#).
2. Remove four (4) screws (A) securing the LCD panel in place ([Figure 1-31](#)).

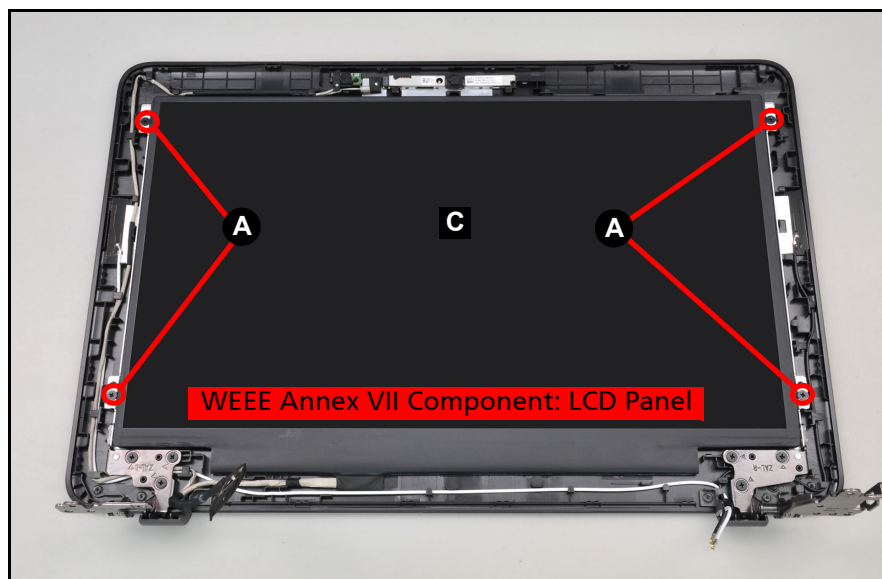

Figure 1-31. LCD Panel Removal

3. Carefully flip the LCD panel over so that the LCD panel faces down and is placed on a flat surface as shown in [Figure 1-32](#).
4. Peel back the piece of adhesive tape securing the eDP cable to the LCD panel connector (D) ([Figure 1-32](#)).

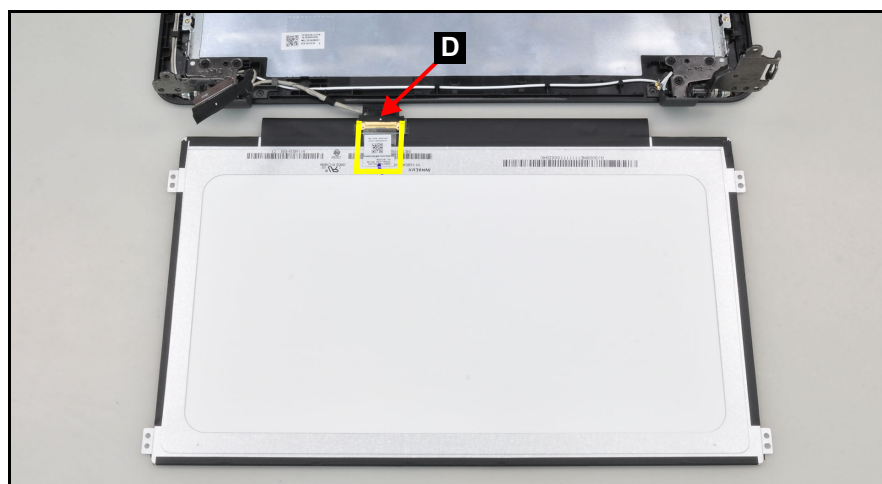

Figure 1-32. LCD Panel Removal

5. Disconnect the eDP cable from the LCD panel connector (D) (Figure 1-33).

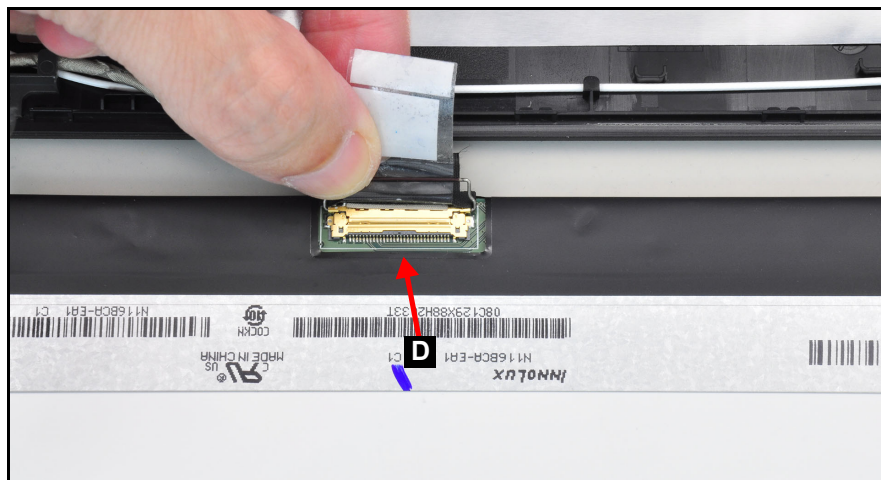

Figure 1-33. LCD Panel Removal

6. Remove the LCD panel.

Top Assembly Removal (Keyboard Removal)

Prerequisite:

Ensure that the **Mainboard**, **USB Board**, and **Speakers** have been disassembled prior removing the top assembly.

⇒ NOTE:

The keyboard is included as part of the top assembly and can not be disassembled. In the event that the keyboard can no longer be used, replace the entire top assembly.



Figure 1-34. Top Assembly (Keyboard)

Troubleshooting

This chapter shows you how to deal with common system problems. Read it before calling a technician if a problem occurs. Solutions to more serious problems require opening up the computer. Do not attempt to open the computer yourself; contact your dealer or authorized service center for assistance.

Recover your Chromebook

When your Chromebook's operating system (OS) isn't working properly, you can recover it. Recovery is removing and reinstalling the OS.

⇒ **NOTE:**

If you're using your Chromebook at work or school, ask [your administrator](#) for help.

Administrators: For more help, contact Google support.

When to recover

You might want to recover if:

- You see this error message: "Chrome OS is missing or damaged".
- You've tried [other troubleshooting steps](#) and nothing has fixed your issue.
- You've asked the experts in our [help forum](#) for help fixing your issue, and they recommend recovery.

What you need to get started

- The Chromebook with the "Chrome OS is missing or damaged" error.
- Another Chromebook, or a Windows or Mac computer with Chrome installed.
- A USB flash drive that can hold at least 8 GB, and that you don't mind erasing. If your Chromebook has an SD card slot, you can use an SD card instead.

+ **IMPORTANT:**

Recovery permanently erases everything on your Chromebook's hard drive, including your downloaded files. If possible, [back up your files](#) before you recover your Chromebook.

What you need to do

Step 1: Try less invasive steps



If you can sign in to your Chromebook, try these steps first:

1. Turn your Chromebook off, then back on again.
2. If your Chromebook still has an error, [reset to factory settings](#).

If neither of those steps fix the error, continue to Step 2.



Step 2: Download a new copy of the OS

On the working computer (not the Chromebook with the error):

1. If you're using a Mac or Windows computer:
 - a. If you haven't yet, [install Chrome](#).
 - b. Open **Chrome** .
 - c. Install the [recovery extension](#).
2. To open the recovery extension:
 - a. At the top right of your browser window, click **Extensions** .
 - b. To launch the extension popup, click on the "**Chromebook Recovery Utility**" extension. If the extension popup doesn't automatically appear on your screen, [make sure it's turned on](#).
3. Click **Get started**.
4. Click **Select** a model from a list, or type in the model number of the Chromebook you want to recover. To find this number, look at the bottom of the error message on your Chromebook screen.
5. Click **Continue**.
6. Insert your USB flash drive or SD card into the computer.
7. In the dropdown menu, choose the USB flash drive or SD card you inserted.
8. Click **Continue**.
9. Click **Create now**.
10. When you see a message saying that your recovery media is ready, remove the USB flash drive or SD card from the computer.



Step 3: Enter recovery mode

On the Chromebook with the error:

1. If you have anything connected to this Chromebook (such as a mouse or external hard drive), remove it.
2. Enter recovery mode:
 - Chromebook: Press and hold **Esc + Refresh** , then press **Power** . Let go of **Power**. When a message shows on the screen, let go of the other keys.
 - Chromebox: First, turn it off. Using a paper clip or similar object, press and hold the [recovery button](#). Press the **Power** button to turn the Chromebox back on. When you see a message on screen, release the recovery button.
 - Chromebit: First, unplug it from power. Using a paper clip or similar object, press and hold the [recovery button](#). Plug the Chromebit back in to power. When you see a message on screen, release the recovery button.

- Chromebook tablet: Press and hold the **Volume Up**, **Volume Down**, and **Power** buttons for at least 10 seconds, then release them.
3. You'll see one of these messages:
 - "Chrome OS is missing or damaged. Please insert a recovery USB stick or SD card."
 - "Please insert a recovery USB stick or SD card."
 4. Insert the USB flash drive or SD card that you used to create recovery media.
 5. Follow the on-screen instructions.



Make sure the recovery extension is turned on

1. On your computer, open **Chrome** .
2. At the top right, click **Extensions**  > **Manage extensions**.
3. Next to "Chromebook Recovery," toggle the switch to the right.
4. Optional: You can also click **Details** and toggle the switch to the right.
5. Once the extension is on, in the extension panel in your browser, click on the extension to open the popup.
6. Optional: If you use the extension frequently, you can pin it .

Optional: Reuse your USB flash drive or SD card

After recovering your Chromebook, you'll need to erase the recovery media if you want to reuse your USB flash drive or SD card to store other files.

To erase the recovery media:

1. On your computer, open **Chrome** .
2. At the top right, click **Extensions** .
3. To launch the extension popup, click on the "**Chromebook Recovery Utility**" extension.
4. In the extension popup, click **Settings** .
5. Click **Erase recovery media**.
6. From the dropdown menu, select the USB drive or SD card you'd like to erase.
7. Click **Continue**.
8. Make sure the storage device you used for recovery is listed.
9. Click **Erase now**.
10. The tool will erase everything on your USB drive or SD card. When you see the message "Your recovery media has been erased," click **Done**.
11. Remove the USB flash drive or SD card from the computer.
12. Format the storage device using a tool provided by your operating system.

Fix problems with recovery

"An unexpected error has occurred".

1. [Erase the storage device](#), then [try recovery again](#).
2. Try using a different USB flash drive or SD card to recover. Some USB flash drives and SD cards don't work well with recovery.

If you're still having problems, contact your Chromebook manufacturer for help. [Learn how to contact your manufacturer](#).

"Please remove all connected devices and start recovery".

First, remove anything that's connected to your Chromebook, such as a mouse, SD card or external hard drive. Then follow the steps to [enter recovery mode](#).

"The device you inserted does not contain Chrome OS".

First, make sure that you inserted the USB drive or SD card that you used to create recovery media.

If you're using the correct storage device, but still see this error, the storage device might not be working properly.

1. [Erase the storage device](#), then [try recovery again](#).
2. Try using a different USB flash drive or SD card to recover. Some USB flash drives and SD cards don't work well with recovery.

If you're still having problems, contact your Chromebook manufacturer for help. [Learn how to contact your manufacturer](#).

"The security module on this device is not working".

First, ask our experts for help:

- "If you use your Chromebook at work or school, contact your administrator. Administrators: contact Google support.
- "Chat with experts on the [Chromebook help forum](#).

If you're still having problems, contact your manufacturer to repair your Chromebook. [Learn how to contact your manufacturer](#).

FRU (Field Replaceable Unit) List

Please contact your local service center to find out how to obtain the part or replace your device.

Exploded Diagrams

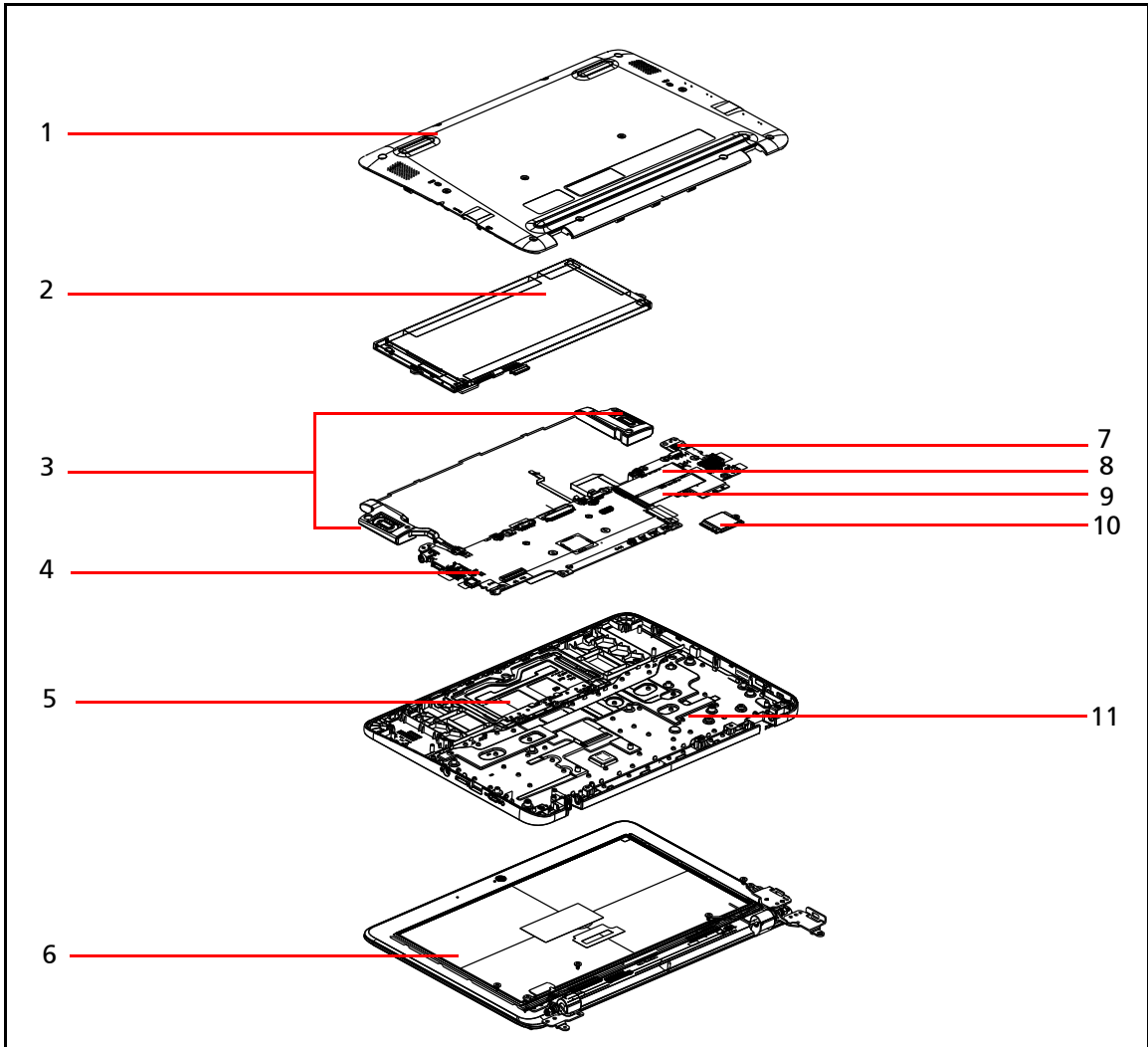

Figure 1-35. System Exploded Diagram

Table 1-1. System Exploded Diagram

No.	Description
1	Base Cover
2	Battery Pack
3	Speakers
4	Mainboard
5	Touchpad Module
6	LCD Module

Table 1-1. System Exploded Diagram (Continued)

No.	Description
7	USB Board
8	USB Board FFC (40-pin)
9	USB Board FFC (30-pin)
10	WLAN Module
11	Top Assembly

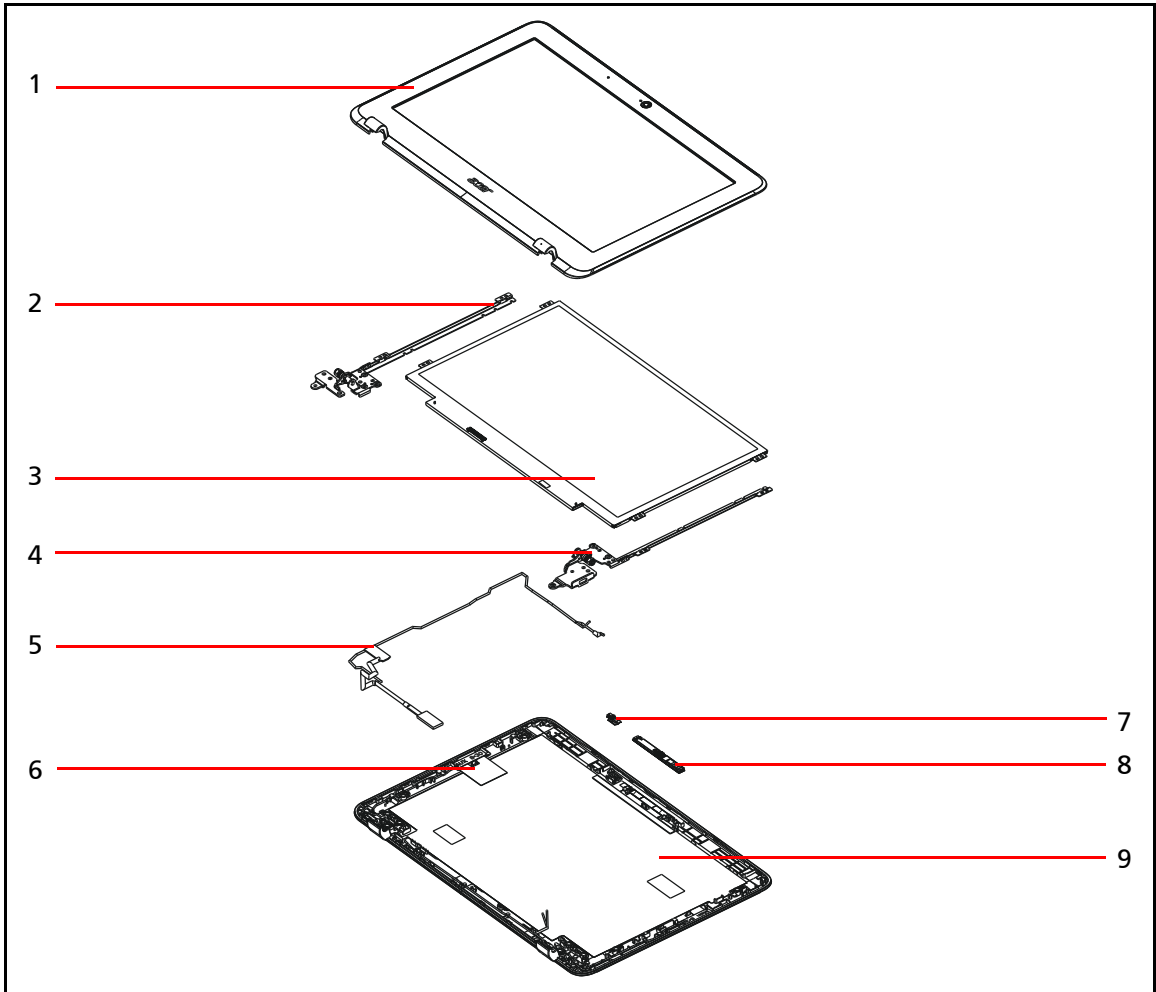



Figure 1-36. LCD Assembly Exploded Diagram

Table 1-2. LCD Assembly Exploded Diagram

No.	Description
1	LCD Bezel
2	LCD Hinge L
3	LCD Panel
4	LCD Hinge R
5	eDP Cable
6	WLAN Antenna (MAIN+AUX)
7	Microphone Board
8	Camera Module
9	LCD Cover

Check for updates yourself

1. Turn on your Chromebook.
2. Connect your Chromebook to Wi-Fi.
3. At the bottom right, select the time.
4. Select **Settings** .
5. At the bottom of the left panel, select **About Chrome OS**.
6. Under "Google Chrome OS", you'll find which version of the Chrome operating system your Chromebook uses.
7. Select **Check for updates**.
8. If your Chromebook finds a software update, it will start to download automatically.

Factory reset your Chromebook

1. Sign out of your Chromebook.
2. Press and hold **Ctrl + Alt + Shift + r**.
3. Select **Restart**.
4. In the box that appears, select **Powerwash > Continue**.
5. Follow the steps that appear and sign in with your Google Account.

⇒ **NOTE:**

The account you sign in with after you reset your Chromebook will be the owner account.